

**Customer Care Solutions**  
**NHL-4/4U Series Transceivers**

# **Troubleshooting Instructions**

[This page left intentionally blank]

Table of Contents

	<b>Page No</b>
RF Troubleshooting .....	4
Introduction to RF troubleshooting .....	4
RF Key component placement .....	5
RF Measurement points .....	6
GSM900 & GSM1800 Transmitter.....	7
General instructions for Tx troubleshooting .....	7
Transmitter troubleshooting diagram .....	9
Pictures of transmitter signals .....	12
GSM900, GSM1800 and GSM1900 Receiver.....	14
General instructions for Rx troubleshooting .....	14
Troubleshooting diagram for GSM900 receiver .....	18
Troubleshooting diagram for GSM1800 receiver .....	19
Troubleshooting diagram for GSM1900 receiver .....	20
Synthesizer .....	21
General instructions for synthesizer troubleshooting.....	21
Synthesizer troubleshooting diagram .....	22
Pictures of synthesizer signals.....	23
Baseband troubleshooting .....	25
Main Troubleshooting Diagram .....	25
Phone is dead .....	26
Flash Programming Fault .....	27
Phone is jammed .....	28
SIM card fault (Insert SIM / Card rejected) .....	29
Keypad Fault .....	30
Display Fault .....	32
Illumination fault .....	33
Charger Fault .....	34
Accessory Fault .....	35
Audio Fault .....	36
FM Radio troubleshooting .....	37
FM Radio component layout .....	37
FM Radio troubleshooting diagram .....	38
Notes to "FM Radio troubleshooting diagram".....	38
Diagrams of FM radio signals.....	40

## RF Troubleshooting

### Introduction to RF troubleshooting

Measurements should be done using Spectrum analyzer with high-frequency high-impedance passive probe (LO-/reference frequencies and RF power levels) and Oscilloscope with a 10:1 probe (DC-voltages and low frequency signals)

The RF-section is build around one RF-ASIC (HELGA N500). For easier troubleshooting, this RF troubleshooting document is divided in to sections.

Before changing HELGA, please check following things: Supply voltages are OK and serial communication coming from baseband to HELGA.

Please note that the grounding of the PA module is directly below PA-module so it is difficult to check or change. **Most RF semiconductors are static discharge sensitive!** So ESD protection must be taken care of during repair (ground straps and ESD soldering irons). HELGA and PA are moisture sensitive so parts must be pre-baked prior to soldering.

Apart from key components described in this document here are a lot of discrete components (resistors, inductors and capacitors) which troubleshooting is done by checking if soldering of the component is done properly (for factory repairs checking if it is missing from PWB). Capacitor can be checked for shortening and resistors for value by means of an ohmmeter, but be aware in-circuit measurements should be evaluated carefully.

Please be aware that all measured voltages or RF levels in this document are rough figures. Especially RF levels varies due to different measuring equipment or different grounding of the used probe. When using RF probe usually a good way is to use metallic tweezers to connect probe ground to PWB ground as close to measurement point as possible.

### RF Key component placement

Figure 1: Component placement 1

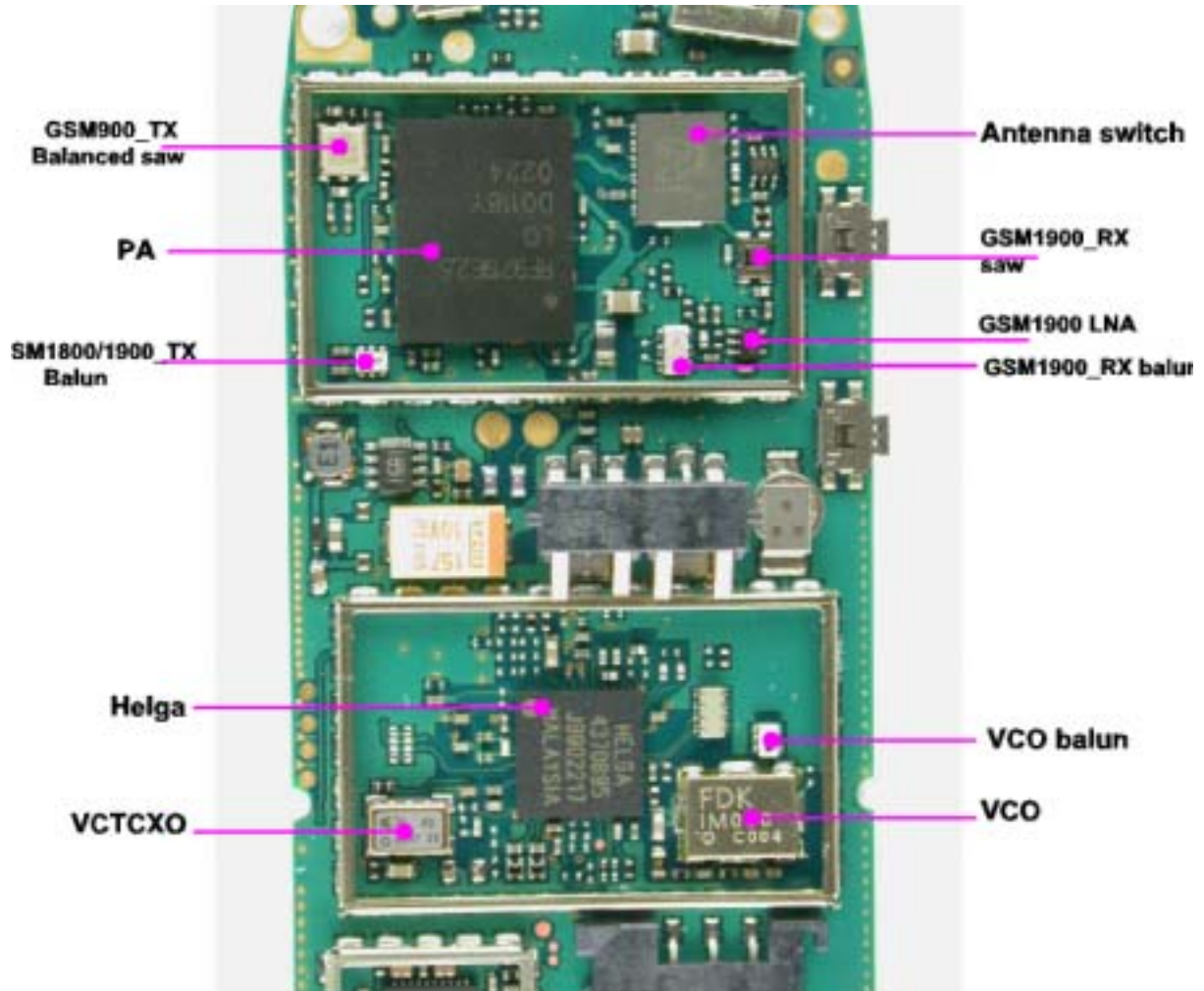

## RF Measurement points

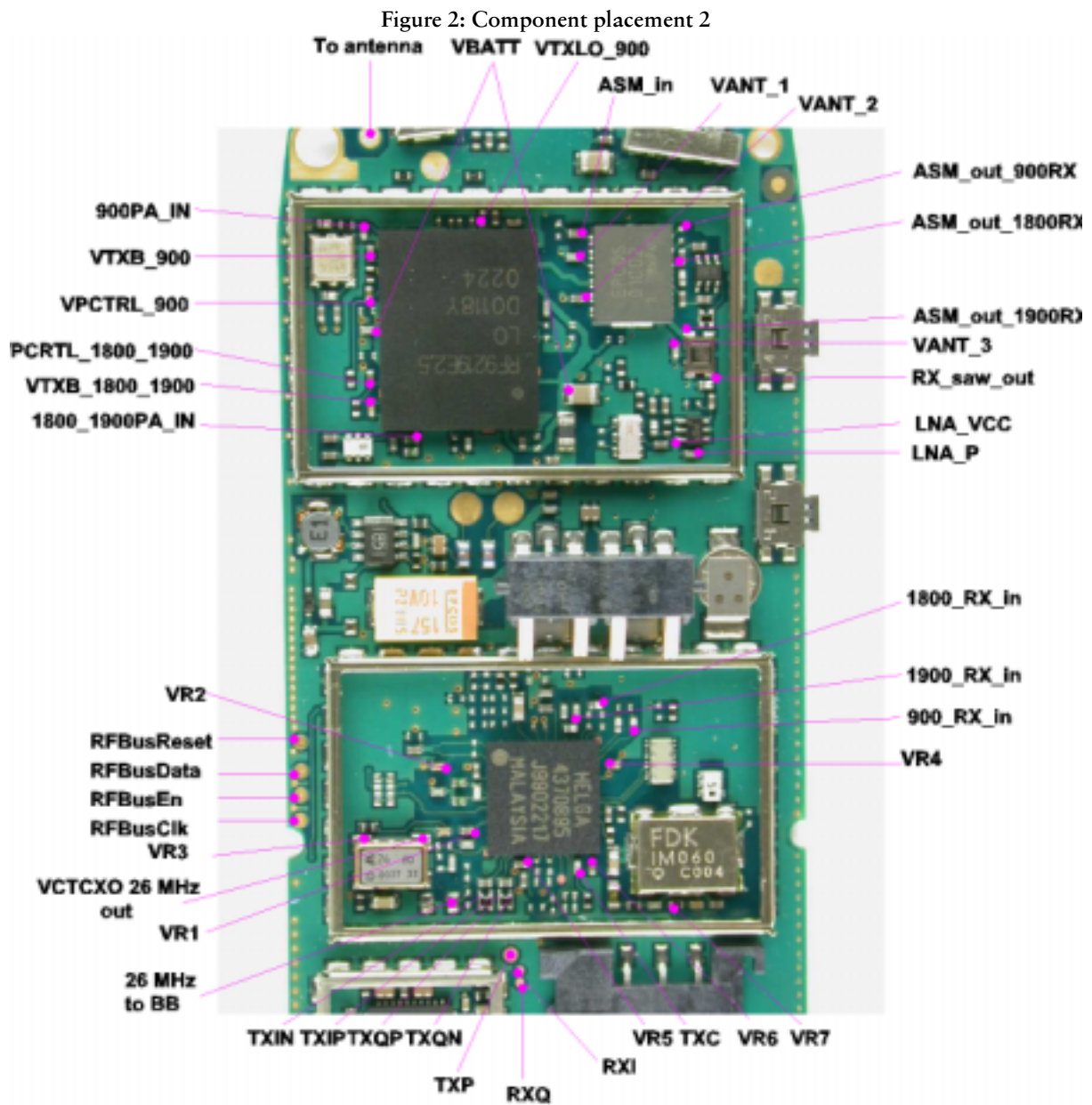

## GSM900 & GSM1800 Transmitter

### General instructions for Tx troubleshooting

Kindly refer to the Service Software Section, Service Concept diagram (p.40)

Connect test jig to computer with DAU-9S cable or to FPS-8 Flash Prommer with XCS-4 modular cable.

Make sure that you have PKD-1 dongle connected to computers parallel port.

Connect DC power supply to module test jig with FLC-2 cable.

**Attention: When repairing or tuning transmitter use external DC supply with at least 3A current capability.** Set the DC supply voltage to 3.9V and set the jumper connector on test jig to "bypass" position.

Connect a RF-cable to the module test jig (MJS-38) RF connector to and to measurement equipment or at least 10dB attenuator, otherwise the PA may be damaged. Normally Spectrum analyzer is used as measurement equipment.

Attention: Normally Spectrum analyzer maximum input power is +30dBm. It is recommended to use 10dB attenuator on Spectrum analyzer input to prevent damage.

Set the phone module to test jig and start Phoenix service software

Initialize connection to phone. (use FBUS driver when using DAU9S and COMBOX driver when using FPS-8)

Select product from the menu

File -> Choose product -> NHL-4

From toolbar set operating mode to "Local"

Activate RF controls window from the menu

Maintenance -> Testing -> RF Controls

From the RF controls window

- Select band "GSM900" or "GSM 1800" or "GSM1900" (Default = "GSM900")
- Set Active unit to "Tx" (Default = "Rx")
- Set Operation mode to "Burst" (Default = "Burst")
- Set Tx data type to "Random" (Default = "All1")

- Set Rx/Tx channel to 37 on GSM900 band or 700 on GSM1800 band or 661 on GSM1900 (Defaults)
- Set Tx PA mode to "Free" (Default)
- Set power level to 5 (Default = 19) on GSM900 or to 0 (Default = 15) on GSM1800 or GSM1900



Transmitter troubleshooting diagram

Figure 3: Transmitter troubleshooting

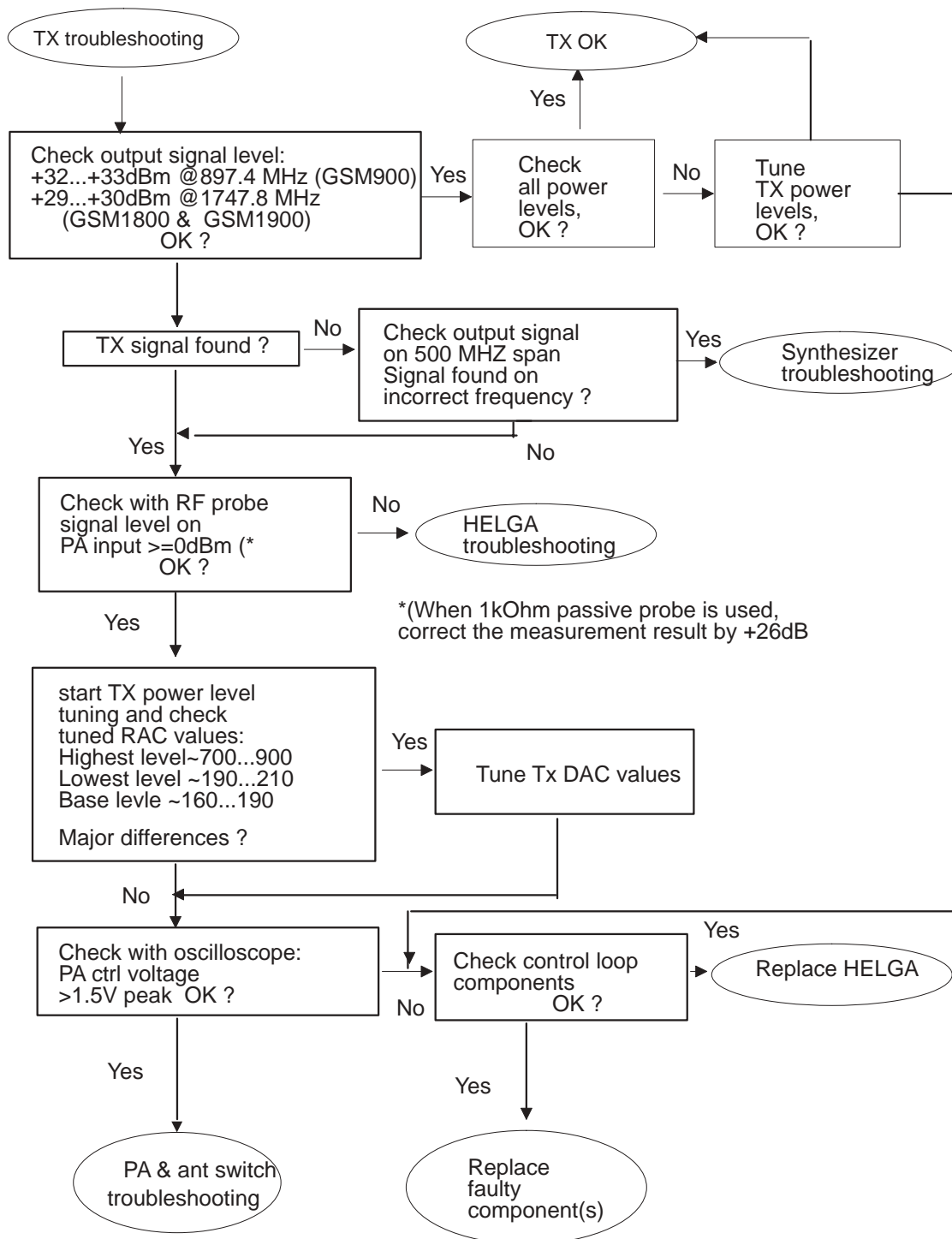

Figure 4: HELGA IC troubleshooting

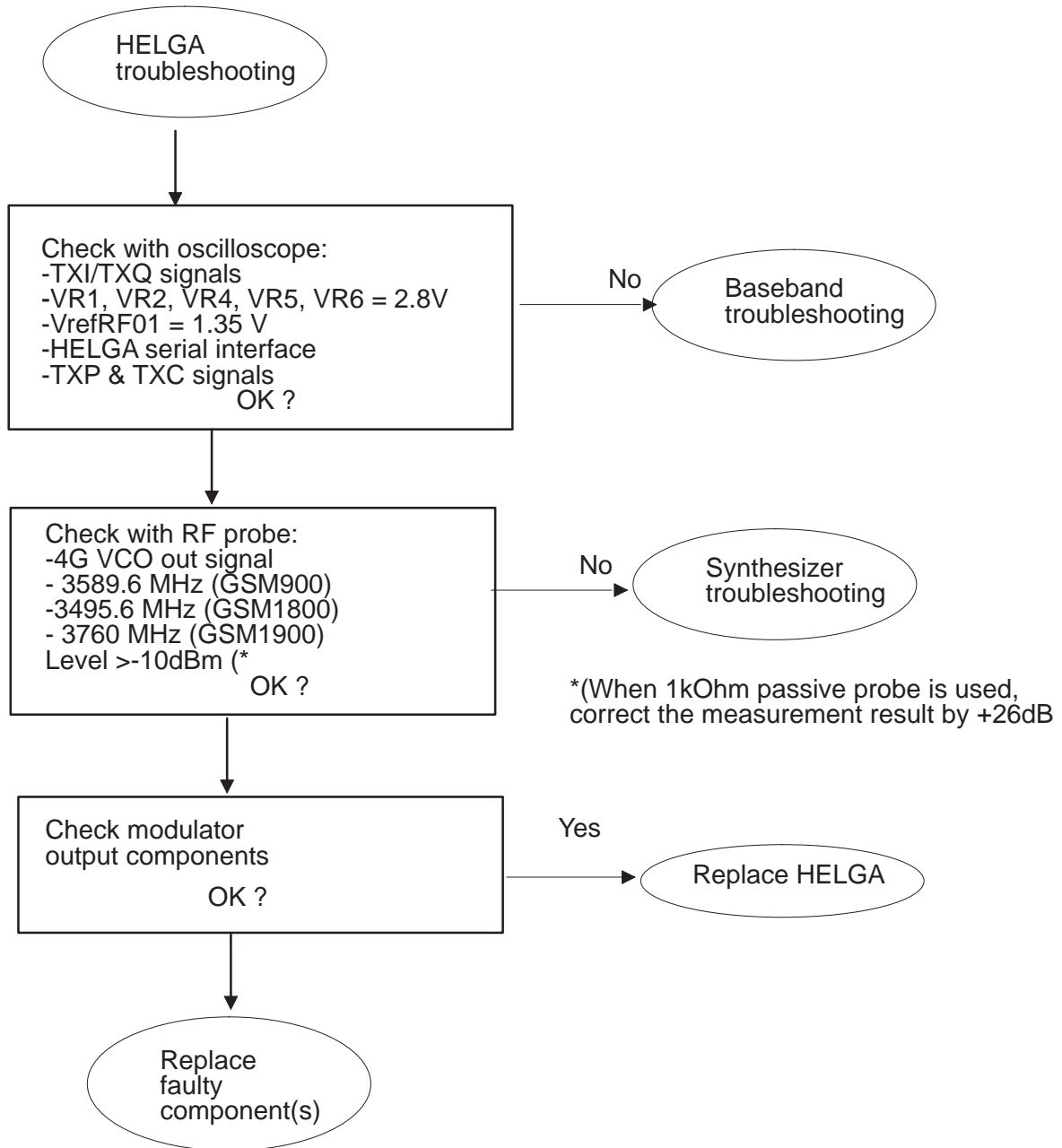
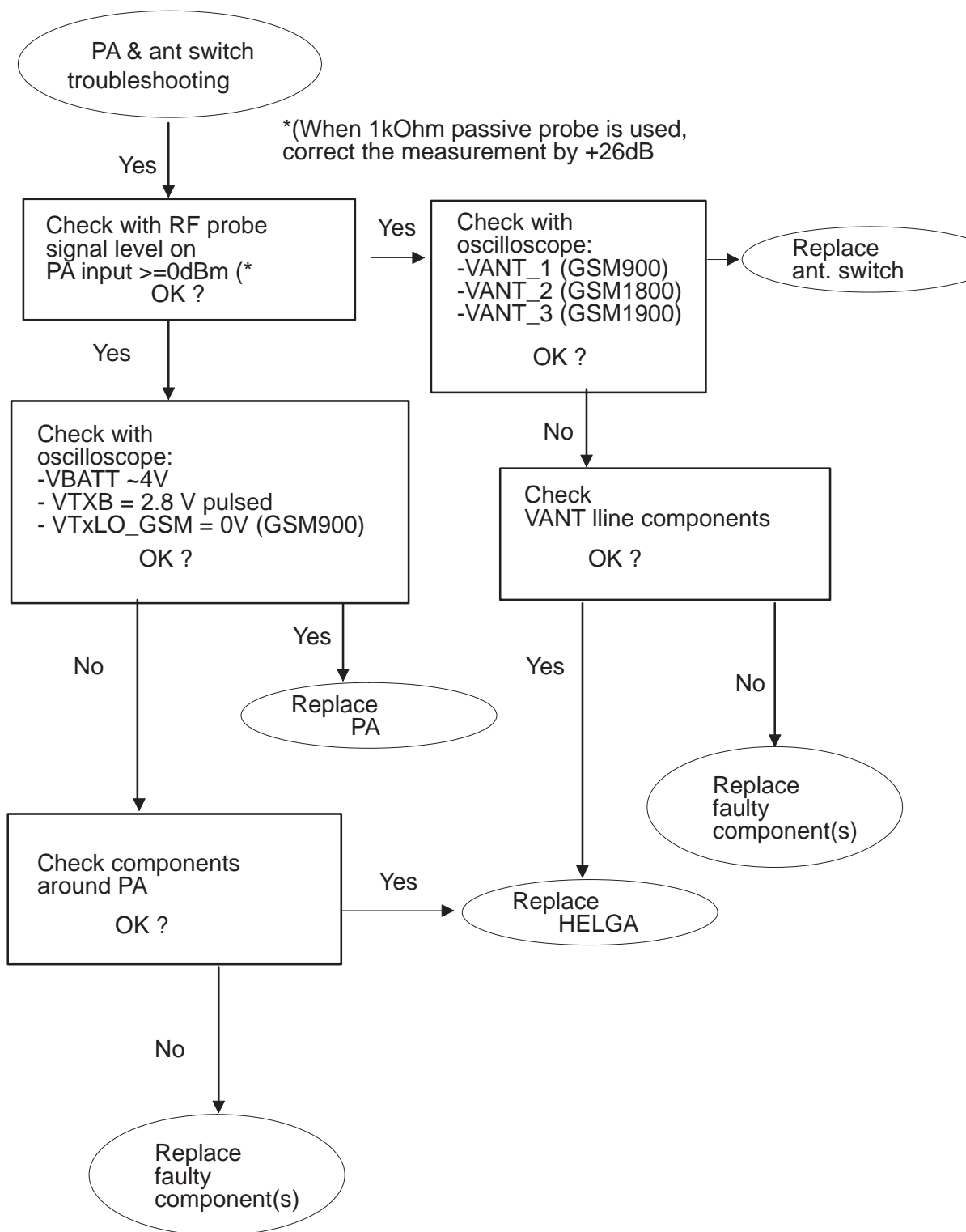

Figure 5: PA and Antenna Switch troubleshooting



Pictures of transmitter signals

Figure 6: Transmitter signals

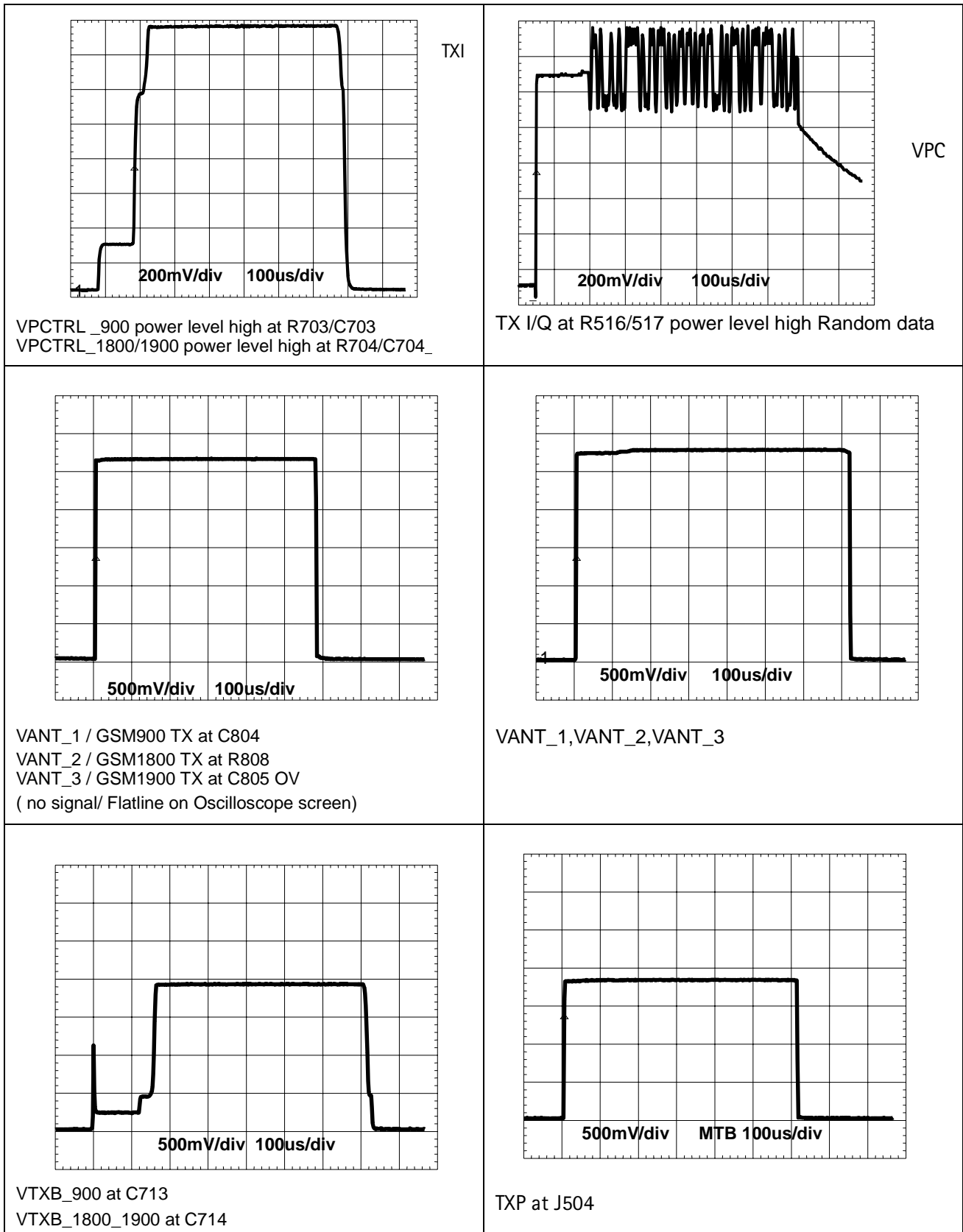
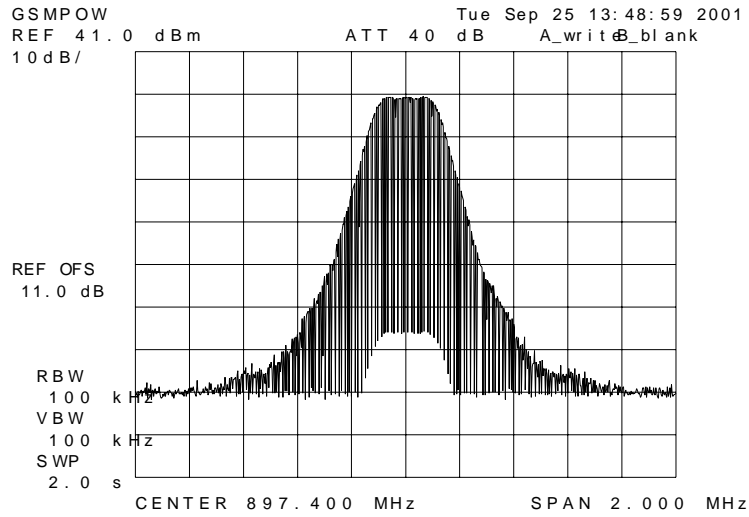

Figure 7: TX OUT signal



Tx out signal, 900 band, burst mode, channel 37

## GSM900, GSM1800 and GSM1900 Receiver

### General instructions for Rx troubleshooting

Connect test jig to computer with DAU-9S cable or to FPS-8 Flash Prommer with XCS-4 modular cable.

Make sure that you have PKD-1 dongle connected to computers parallel port.

Connect DC power supply to module test jig with FLC-2 cable.

Set the DC supply voltage to 6V (test jig has internal voltage regulator of output voltage 4V).

Connect an RF-cable to the module test jig (MJS-38) RF connector and to RF signal generator.

Set the phone module to test jig and start Phoenix service software.

Initialize connection to phone. (use FBUS driver when using DAU9S and COMBOX driver when using FPS-8)

Choose product from the menu

File -> Choose product -> NHL-4

From toolbar set operating mode to "Local"

Activate RF controls window from the menu

Maintenance -> Testing -> RF Controls

From the RF controls window:

- Select band "GSM900", "GSM 1800" or "GSM1900" (Default = "GSM900")

- Set Active unit to "Rx" (Default = "Rx")

- Set Operation mode to "Burst" (Default = "Burst")

For continuous mode:

- Set Operation mode to "Continuous"

- Set AGC to "12: FEG\_ON + DTOS\_ON + BB\_30=Vgain60" (maximum gain setting used in normal mode)

(Default = "14: FEG\_ON + DTOS\_ON + BB\_42=Vgain72")

- Set Rx/Tx channel to 37 on GSM900 band, 700 on GSM1800 band or 661 on GSM1900 (Defaults)

Apply 942.46771 MHz (channel 37 + 67.710 kHz offset), 1842.86771 MHz (channel 700 + 67.710 kHz offset) or 1960.06771 MHz (channel 661 + 67.71 kHz) -90 dBm signal to the RF-connector (remember to compensate for cable attenuation).

Measuring with an oscilloscope on "RXI" or "RXQ" following screens should be seen on a working GSM900 , GSM1800 or GSM1900 receiver:

Figure 8: RX I/Q signal ,burst mode, input level -90dBm.

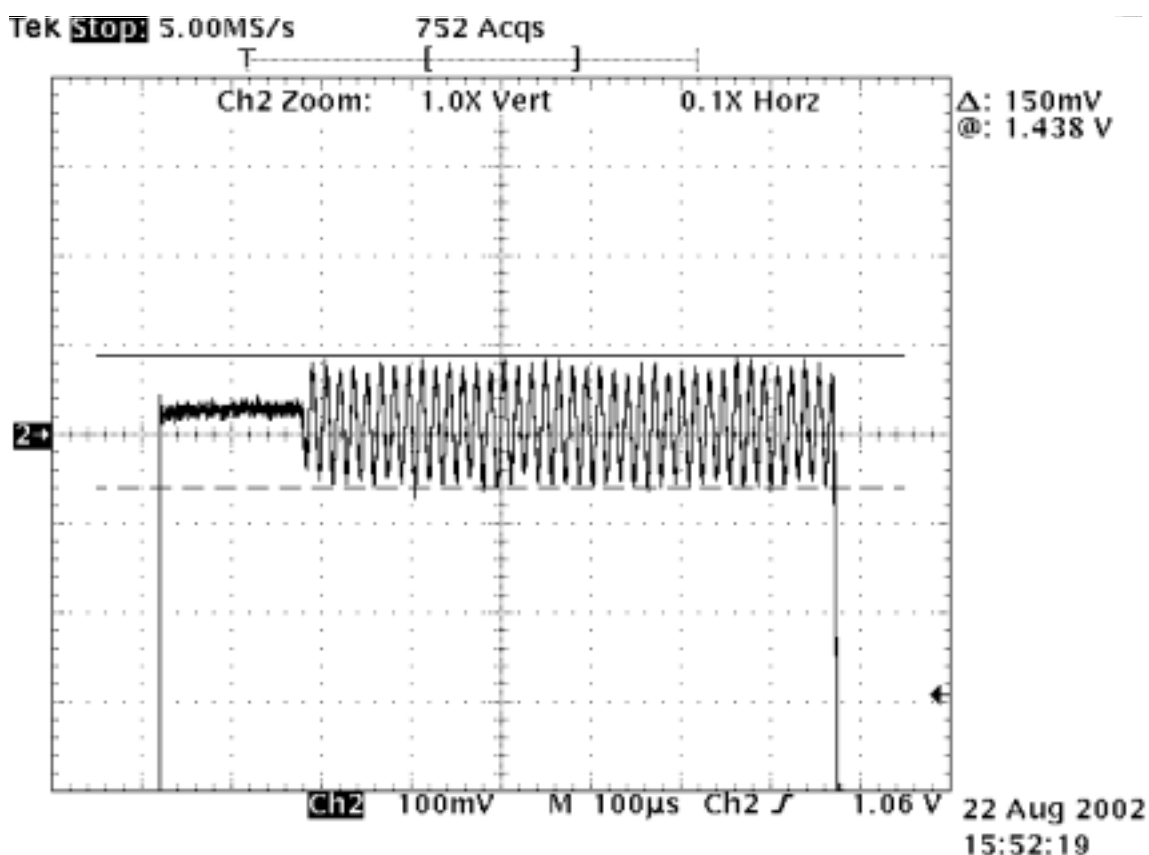

Figure 8, "RX I/Q signal ,burst mode, input level -90dBm.," on page 15: Receiver I or Q burst mode signal (channel 37) measured from testpoint RXI or RXQ with 942.467 MHz signal, input level -90dBm at RF-connector.

Correct signal amplitudes approximately:

- GSM900~170mVpp
- GSM1800~140mVpp
- GSM1900~160mVpp

Signal part frequency 67.7kHz sine.

DC level of signal part is 1.35V. DC level can variate about +/-100mV between I and Q signals and between different bands as well.

Figure 9: GSM1900 RX I or Q signal (trace2), burst mode.

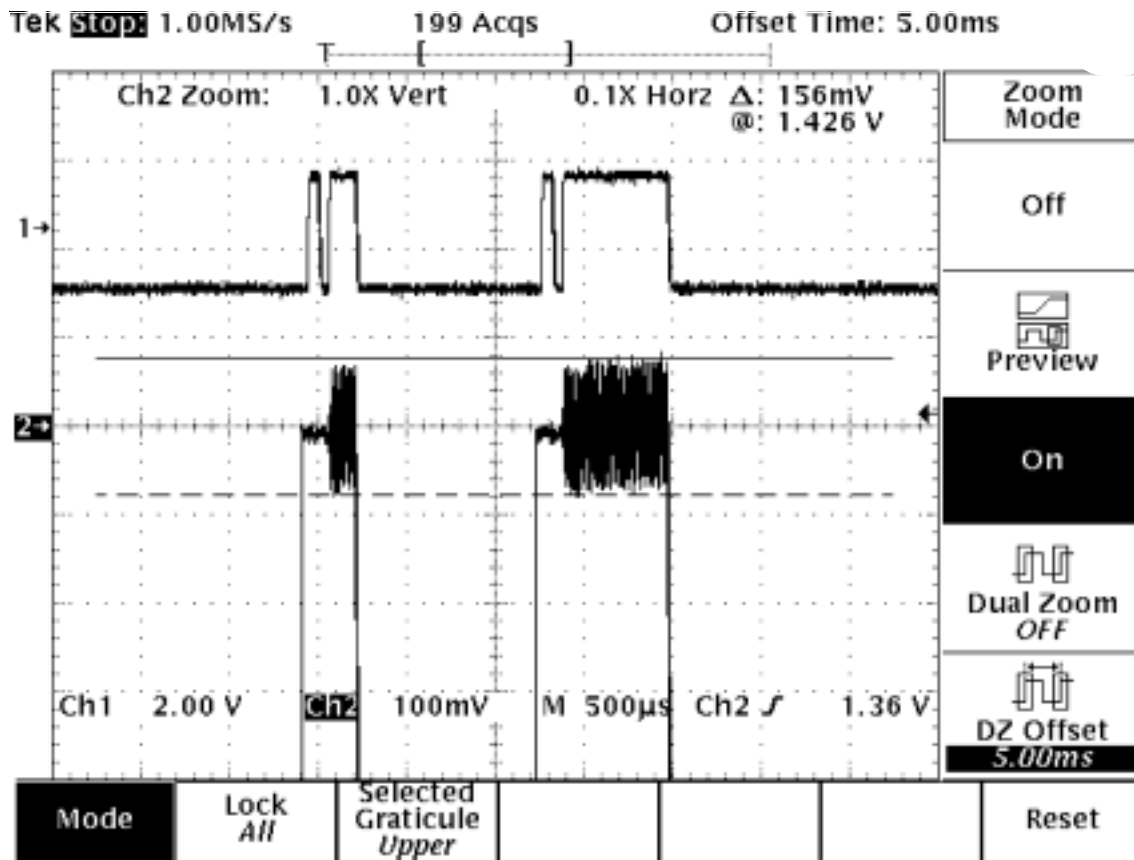

For Figure 9, "GSM1900 RX I or Q signal (trace2), burst mode.," on page 16 GSM1900 receiver burst mode I or Q signal at ch 661 with input signal 1960.067MHz, level -90 dBm at RF-connector.

Trace2: With wider time scaling both monitoring and own RX bursts are seen, 1<sup>st</sup> burst (shorter) is monitoring and 2<sup>nd</sup> burst (longer) is own RX burst.

Trace1: External LNA VCC supply voltage at burst mode, input level -90 dBm. Measured from testpoint LNA\_VCC.



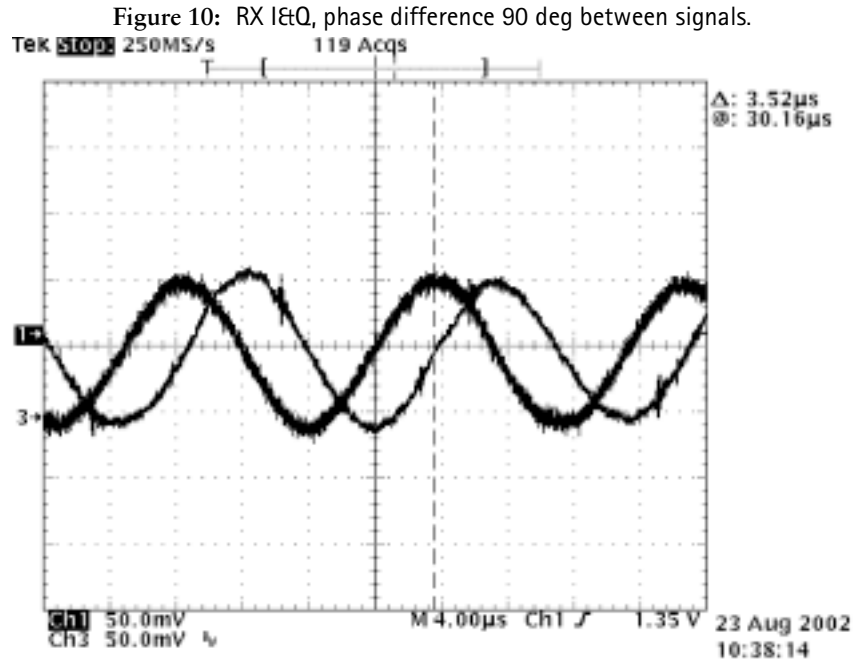

Figure 10, "RX I&Q, phase difference 90 deg between signals.," on page 17:

Detailed view of GSM900 continuous mode RX I and Q signals measured from testpoints RXI and RXQ simultaneously.

Used channel 37, input signal 942.467 MHz, level -90 dBm at antenna port, AGC setting 12.

Phase difference should be 90 degrees between RX I and Q signals at all bands.

Troubleshooting diagram for GSM900 receiver

Phone in "Continuous" mode, AGC setting "12"

Figure 11: GSM900 receiver troubleshooting

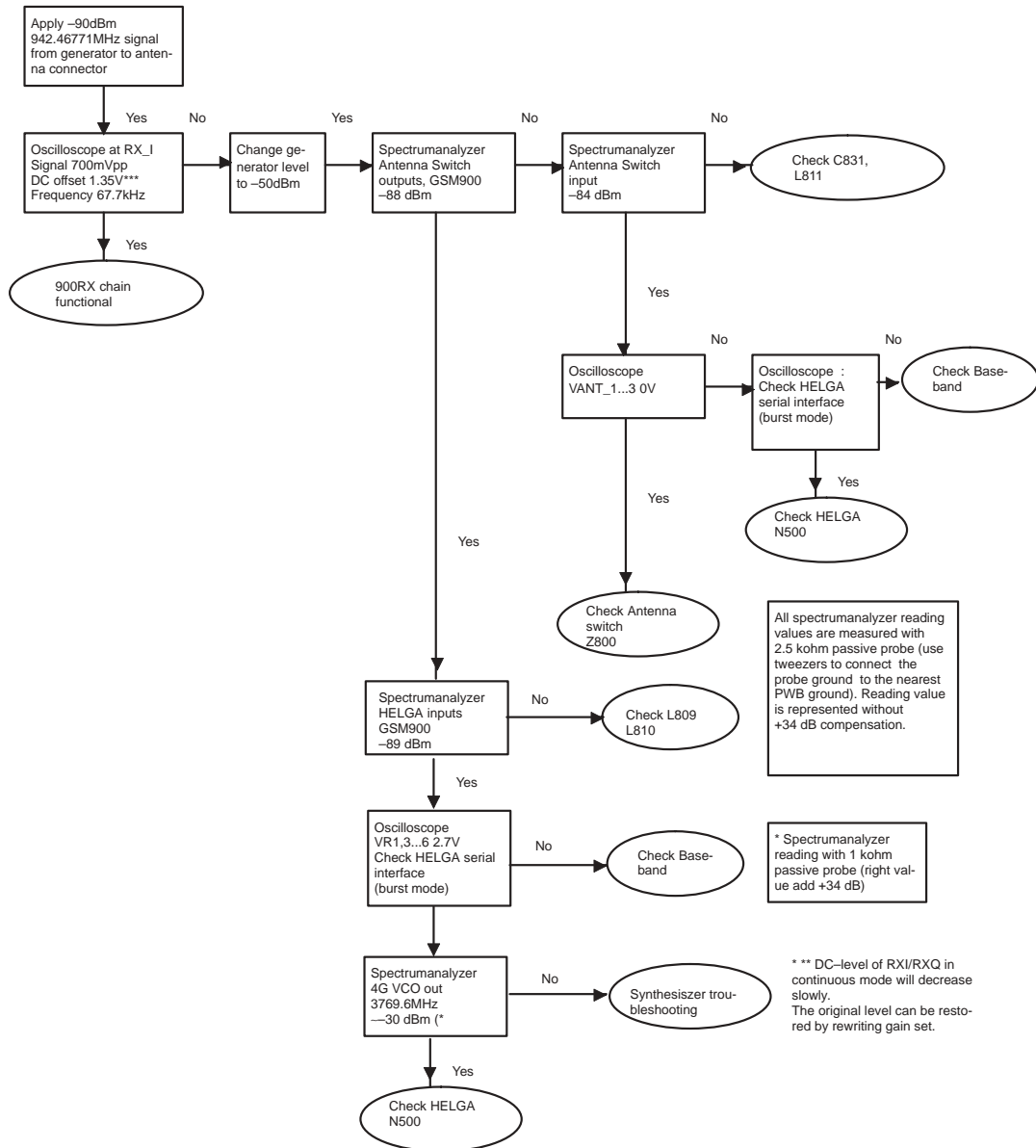

Troubleshooting diagram for GSM1800 receiver

Phone in "Continuous" mode, AGC setting "12"

Figure 12: GSM1800 receiver troubleshooting

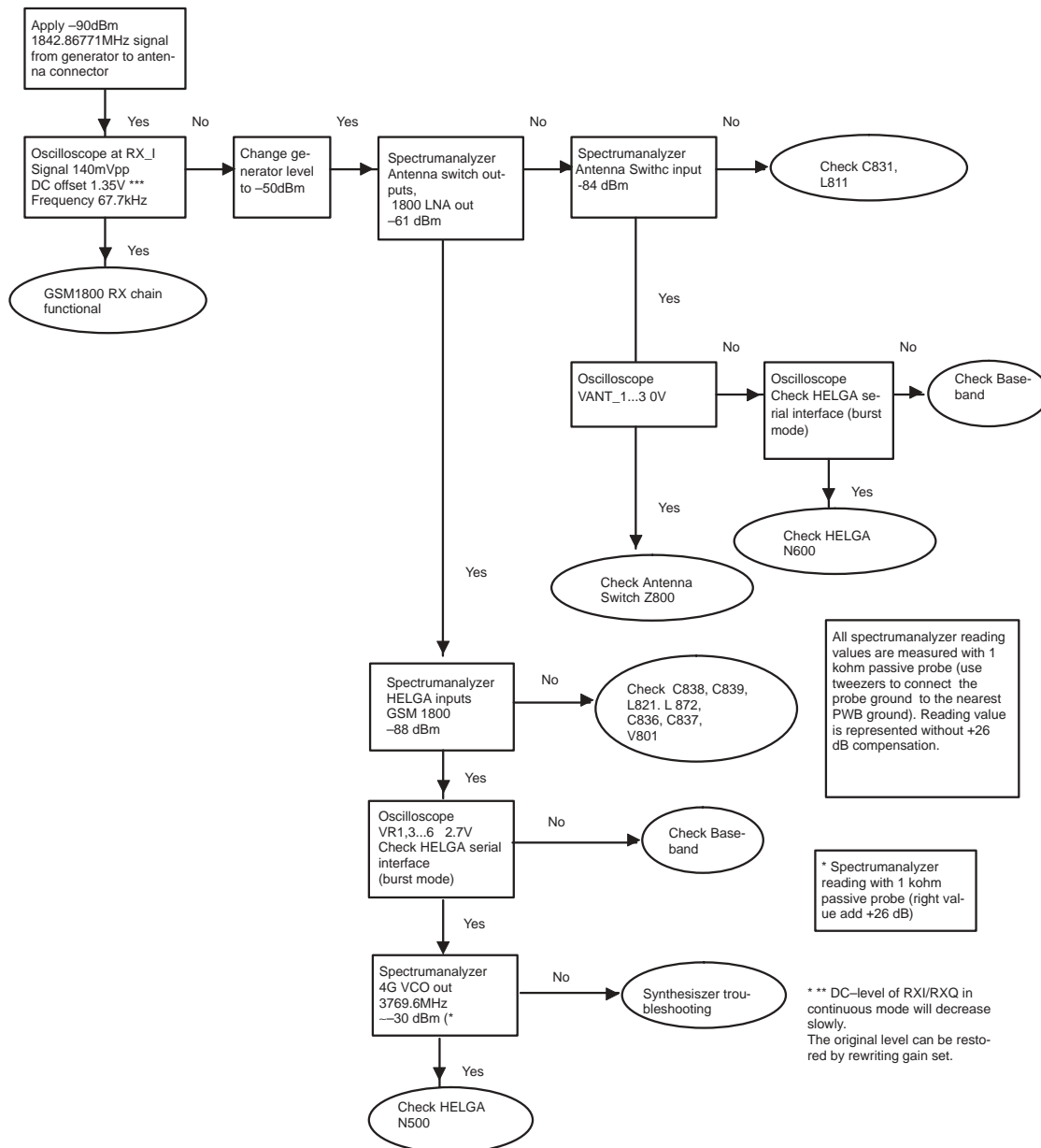

Troubleshooting diagram for GSM1900 receiver

Phone in "Continuous" mode, AGC setting "12"

Figure 13: GSM1900 receiver troubleshooting

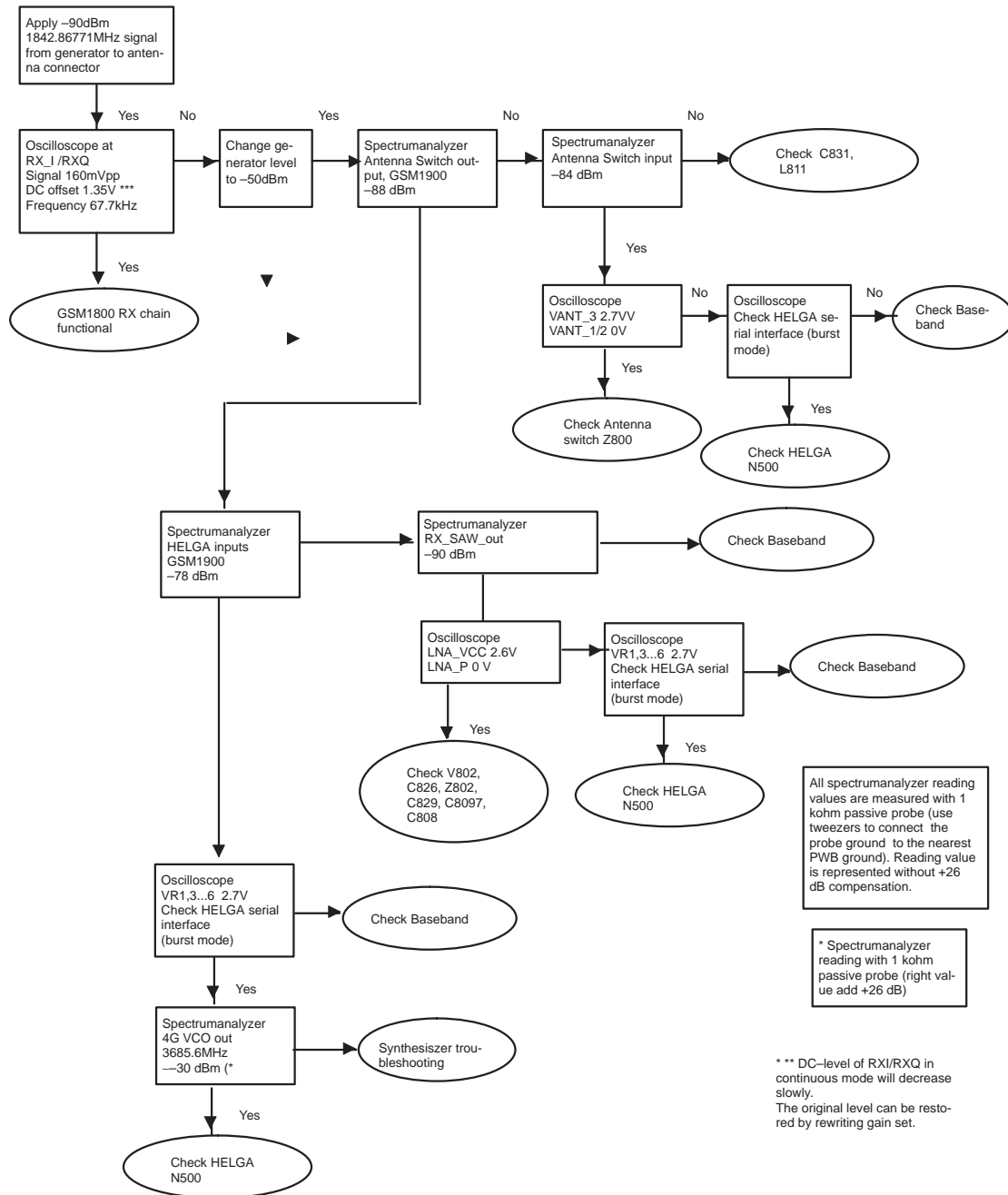

All spectrumanalyzer reading values are measured with 1 kohm passive probe (use tweezers to connect the probe ground to the nearest PWB ground). Reading value is represented without +26 dB compensation.

\* Spectrumanalyzer reading with 1 kohm passive probe (right value add +26 dB)

\*\*\* DC-level of RXI/RXQ in continuous mode will decrease slowly. The original level can be restored by rewriting gain set.

## Synthesizer

### General instructions for synthesizer troubleshooting

Connect test jig to computer with DAU9S cable or to FPS-8 Flash Prommer with XCS-4 modular cable.

Make sure that you have PKD-1 dongle connected to computers parallel port.

Connect DC power supply or FPS-8 to module test jig with PCS-1 cable.

Set the DC supply voltage to 3.9V and set the jumper connector on test jig to "bypass" position.

Set the phone module to test jig and start Phoenix service software

Initialize connection to phone. (use FBUS driver when using DAU9S and COMBOX driver when using FPS-8)

Select product from the menu

File -> Choose product -> NHL-4

From toolbar set operating mode to "Local"

Activate RF controls window from the menu

Maintenance -> Testing -> RF Controls

From the RF controls window

- Select band "GSM900", "GSM 1800" or "GSM1900" (Default = "GSM900")
- Set Active unit to "Rx" (Default = "Rx")
- Set Operation mode to "Continuous" (Default = "Burst")
- Set Rx/Tx channel to 37 on GSM900 band, 700 on GSM1800 band, 661 on GSM1900 band (Defaults)

Synthesizer troubleshooting diagram

Figure 14:

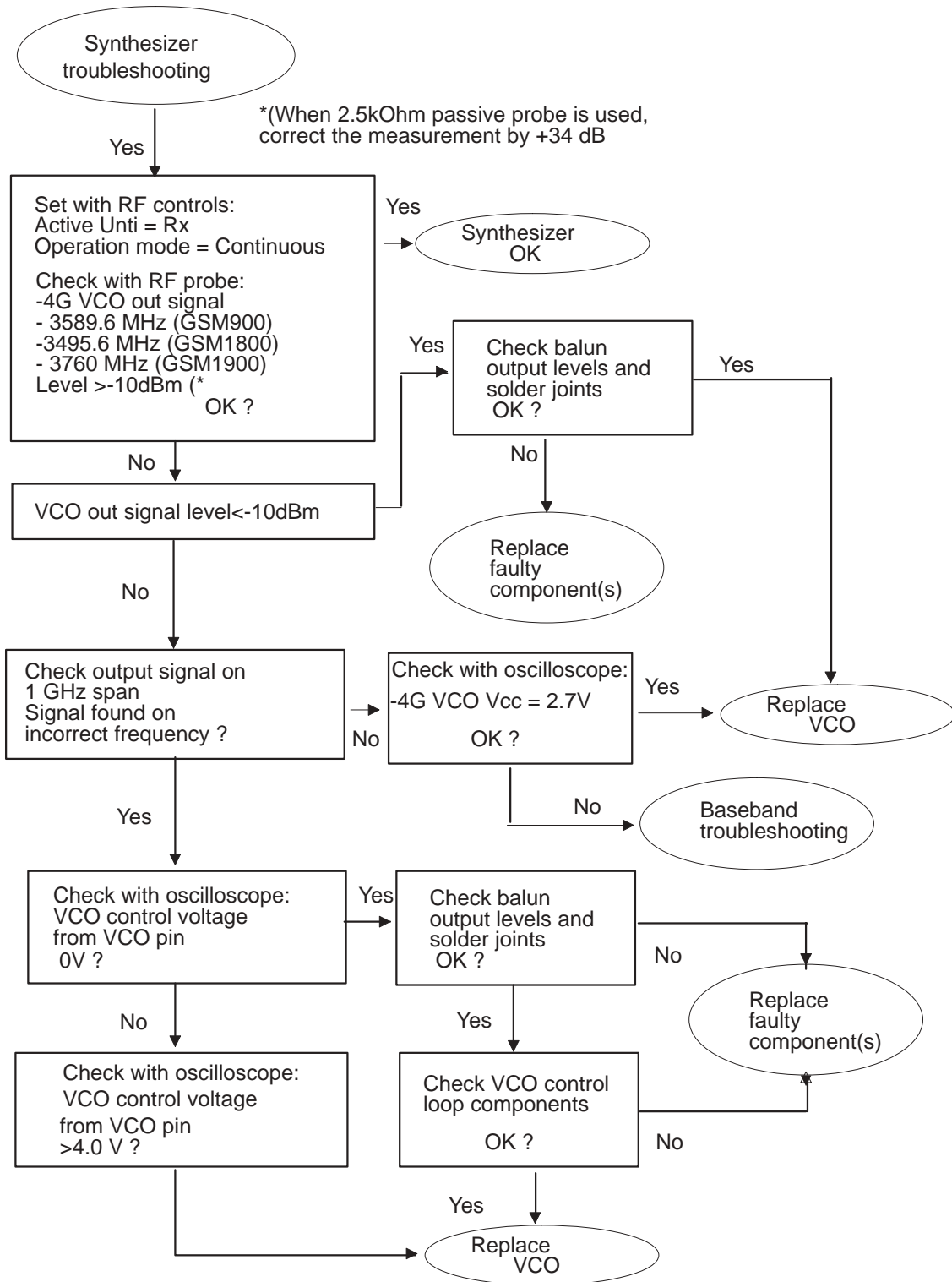

Pictures of synthesizer signals

Figure 15: 26MHz at G501 pin out

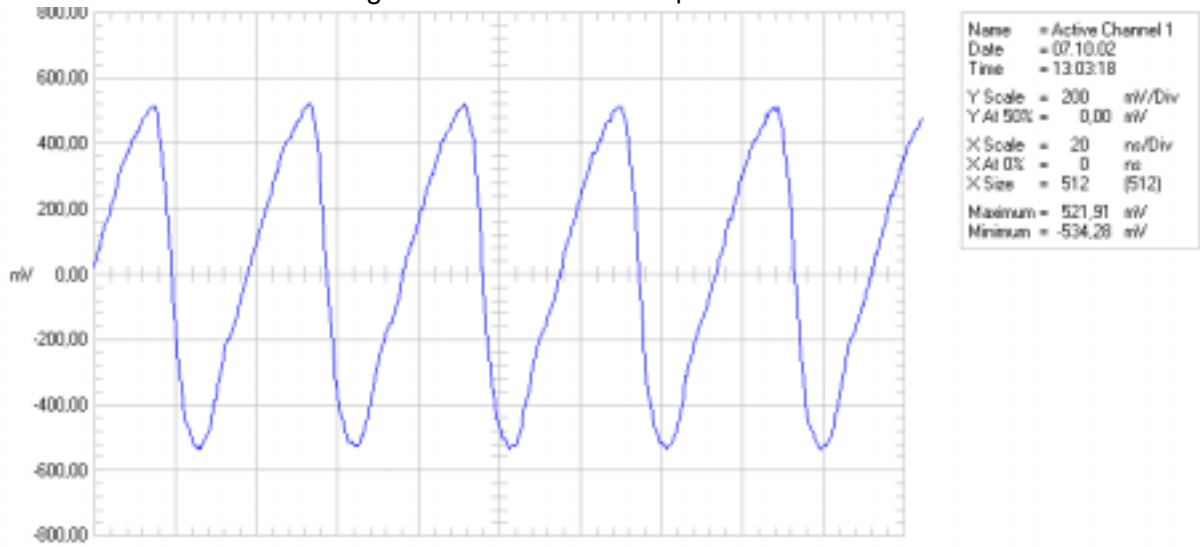

Figure 16: 26MHz RFCLK at R420/C420

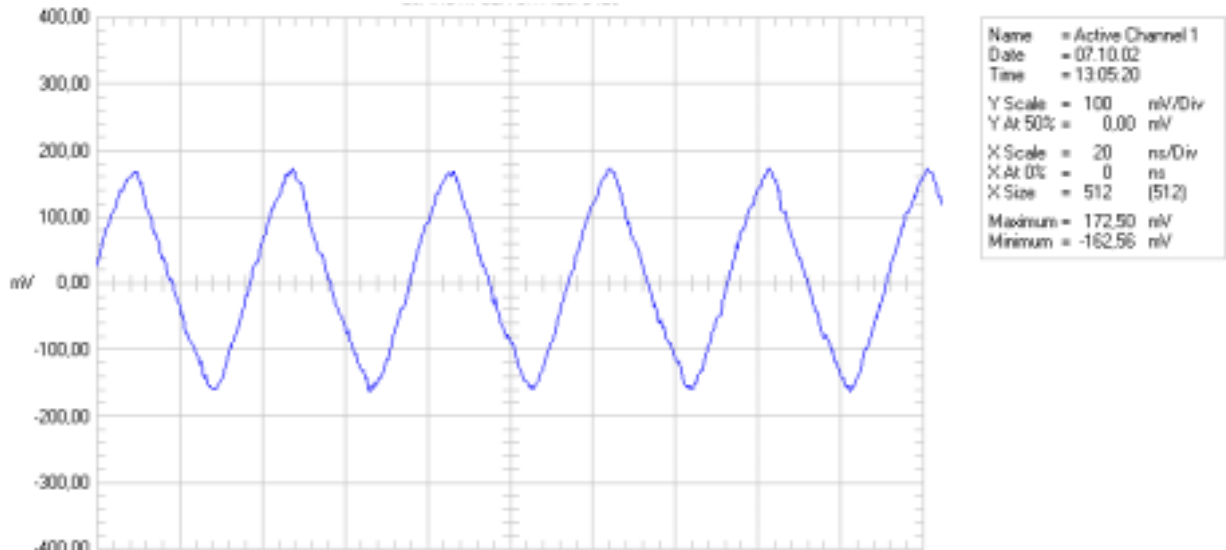

Figure 17: 1800 TX, channel 512, burst mode

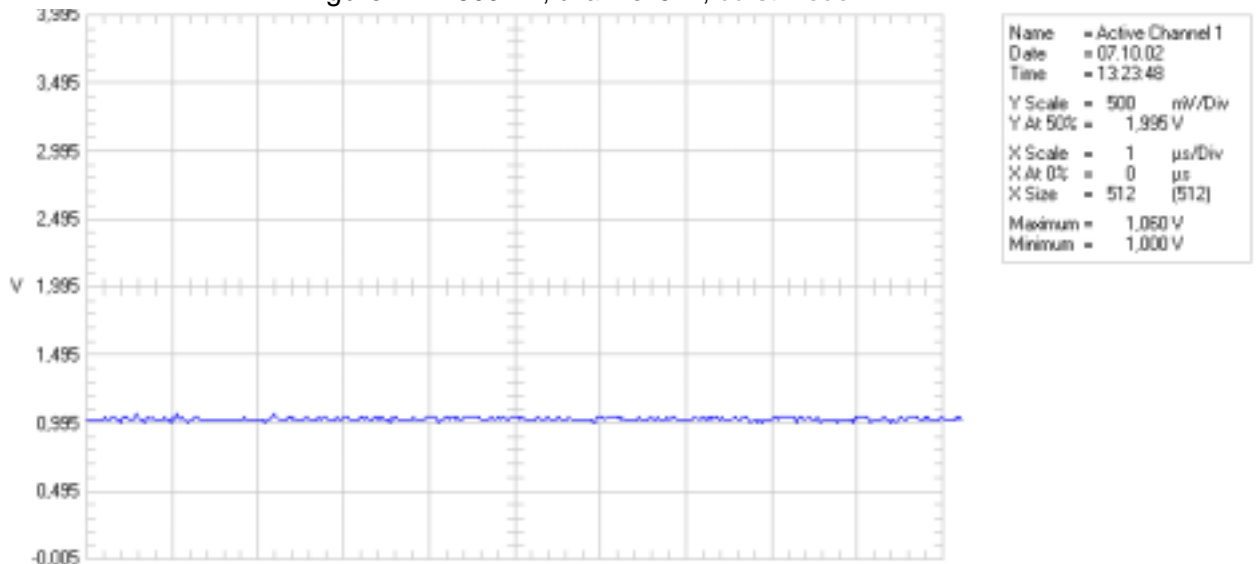

Figure 18: 1900 RX, channel 810, continuous mode

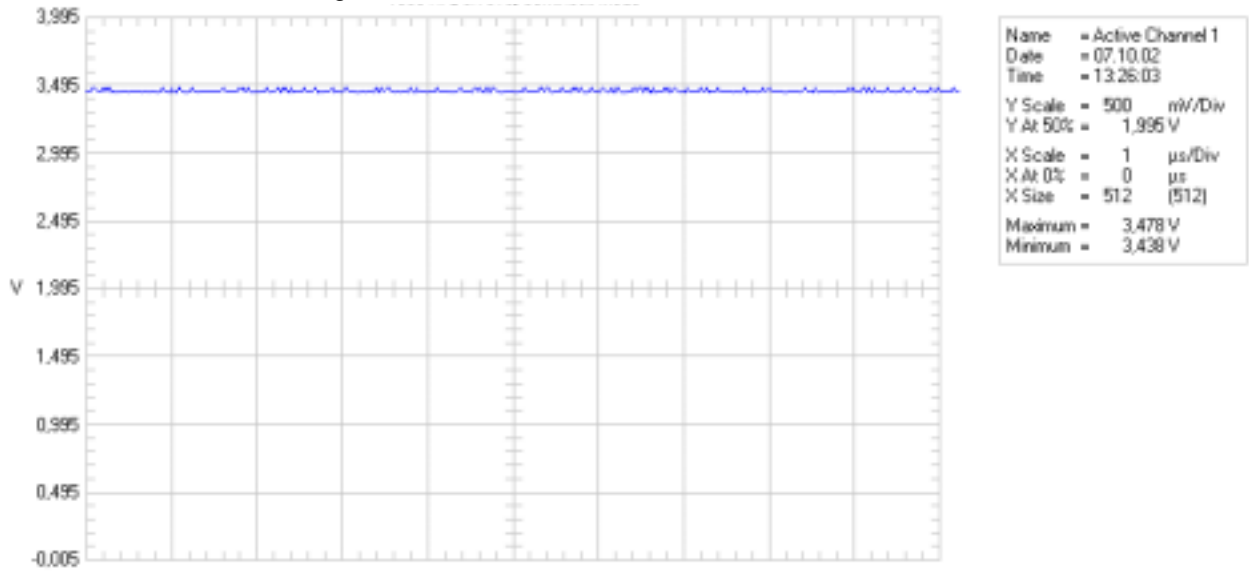
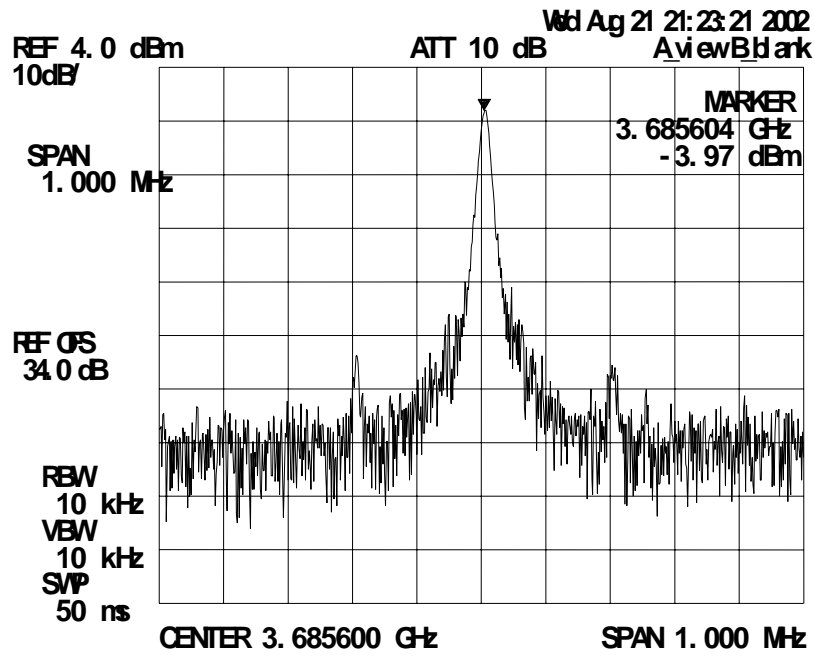

Figure 19: VCO output, 1800 band, RX on, continuous output





# Baseband troubleshooting

The following diagrams describe baseband troubleshooting.

## Main Troubleshooting Diagram

Figure 20: Baseband general troubleshooting

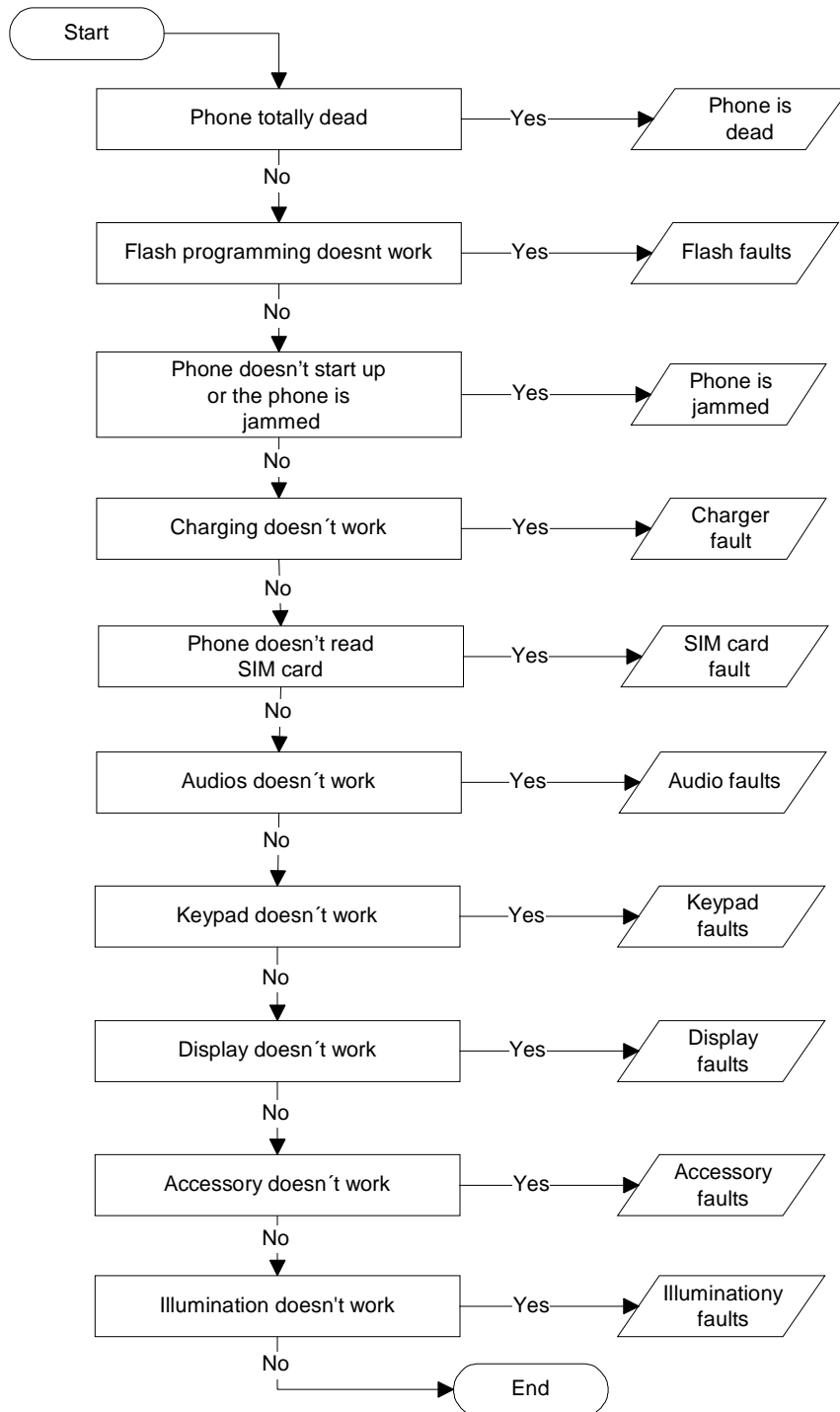

**Phone is dead**

Figure 21: Dead phone troubleshooting

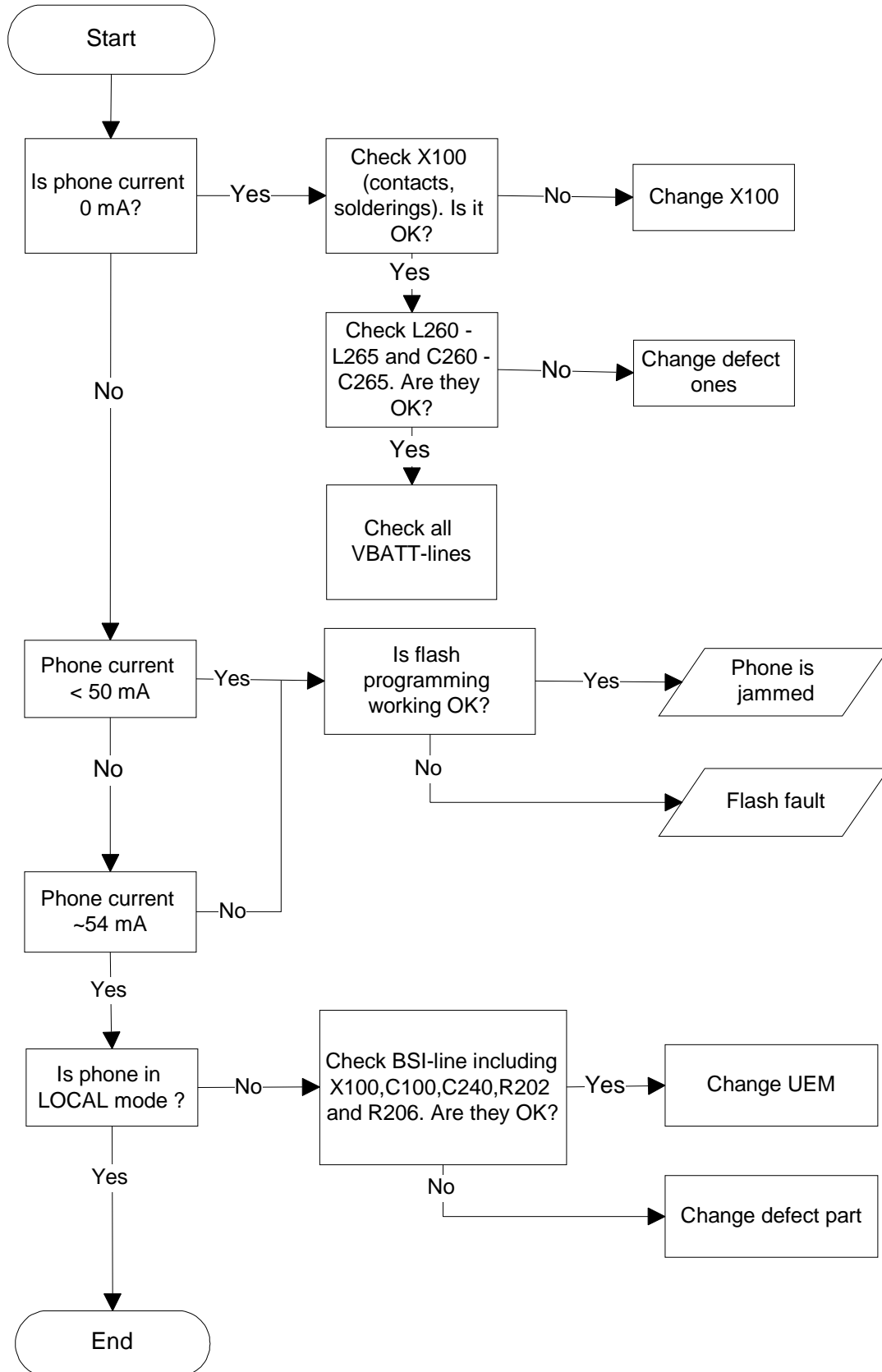

### Flash Programming Fault

Figure 22: Flash programming troubleshooting

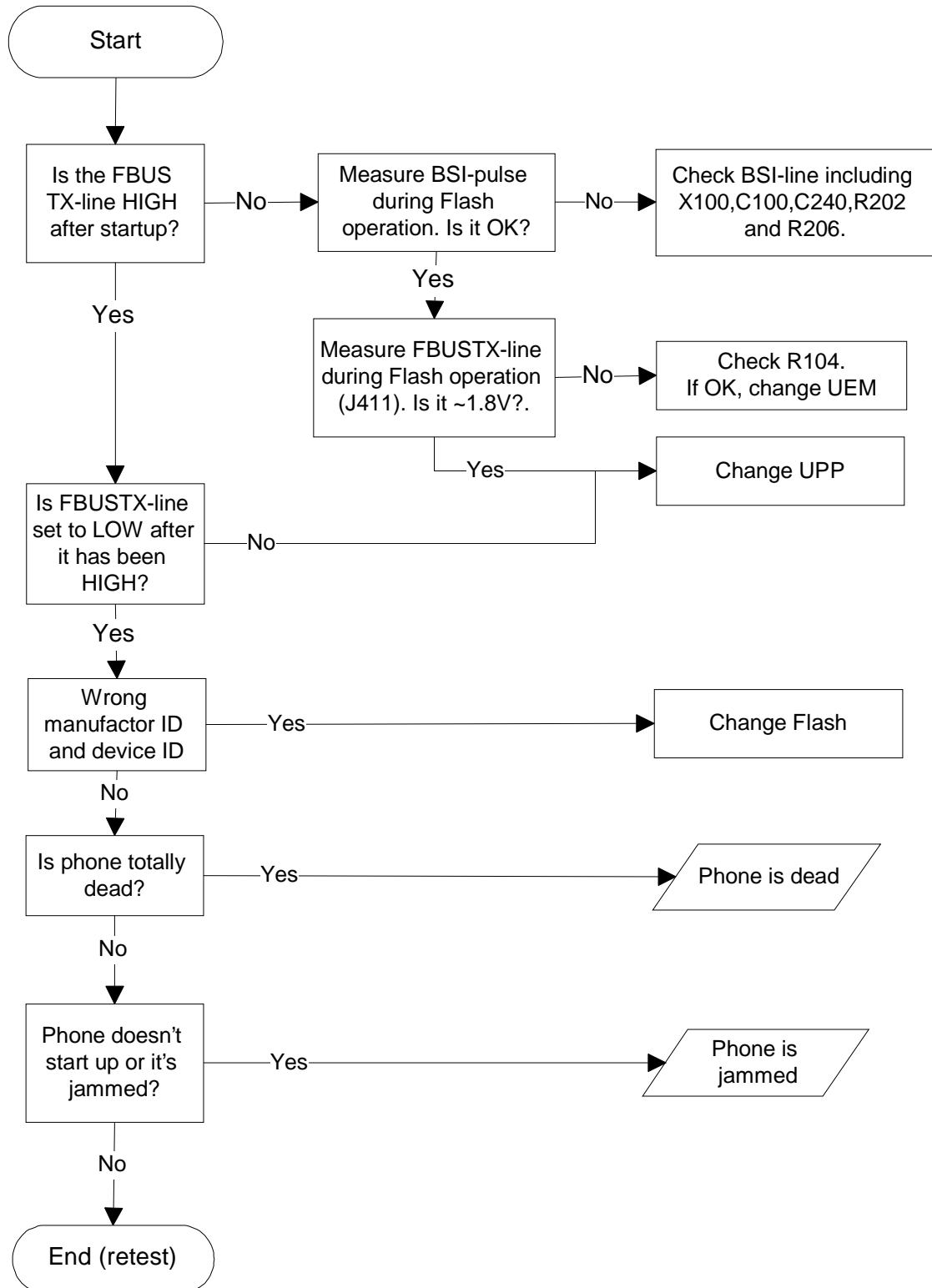

### Phone is jammed

Figure 23: Jammed phone troubleshooting

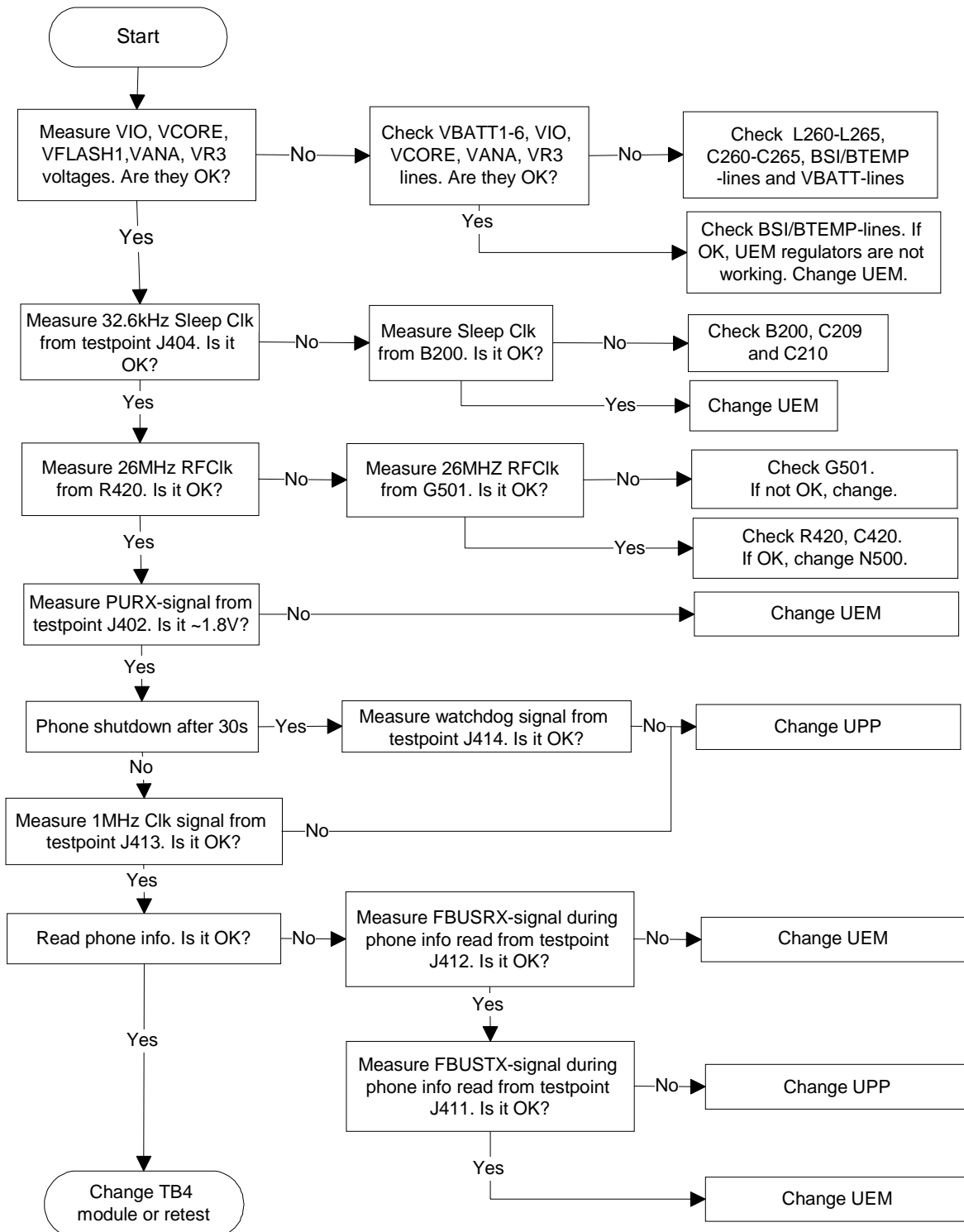

### SIM card fault (Insert SIM / Card rejected)

Figure 24: SIM card troubleshooting

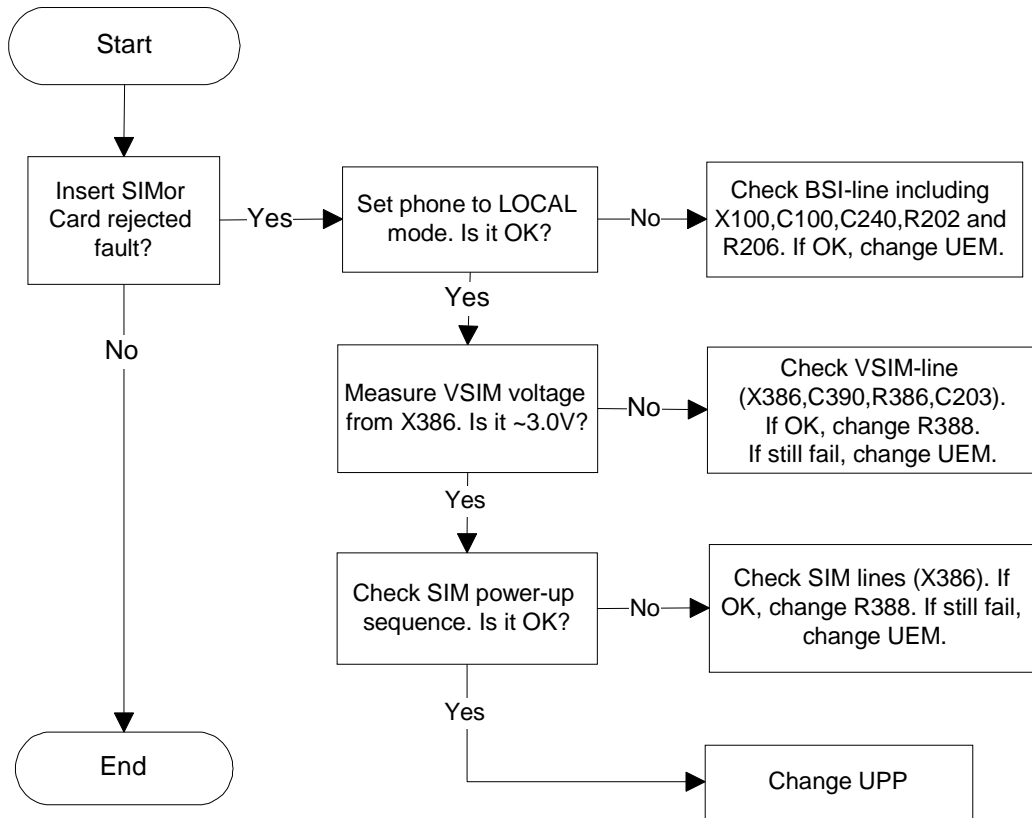

## Keypad Fault

Figure 25: Keypad troubleshooting 1

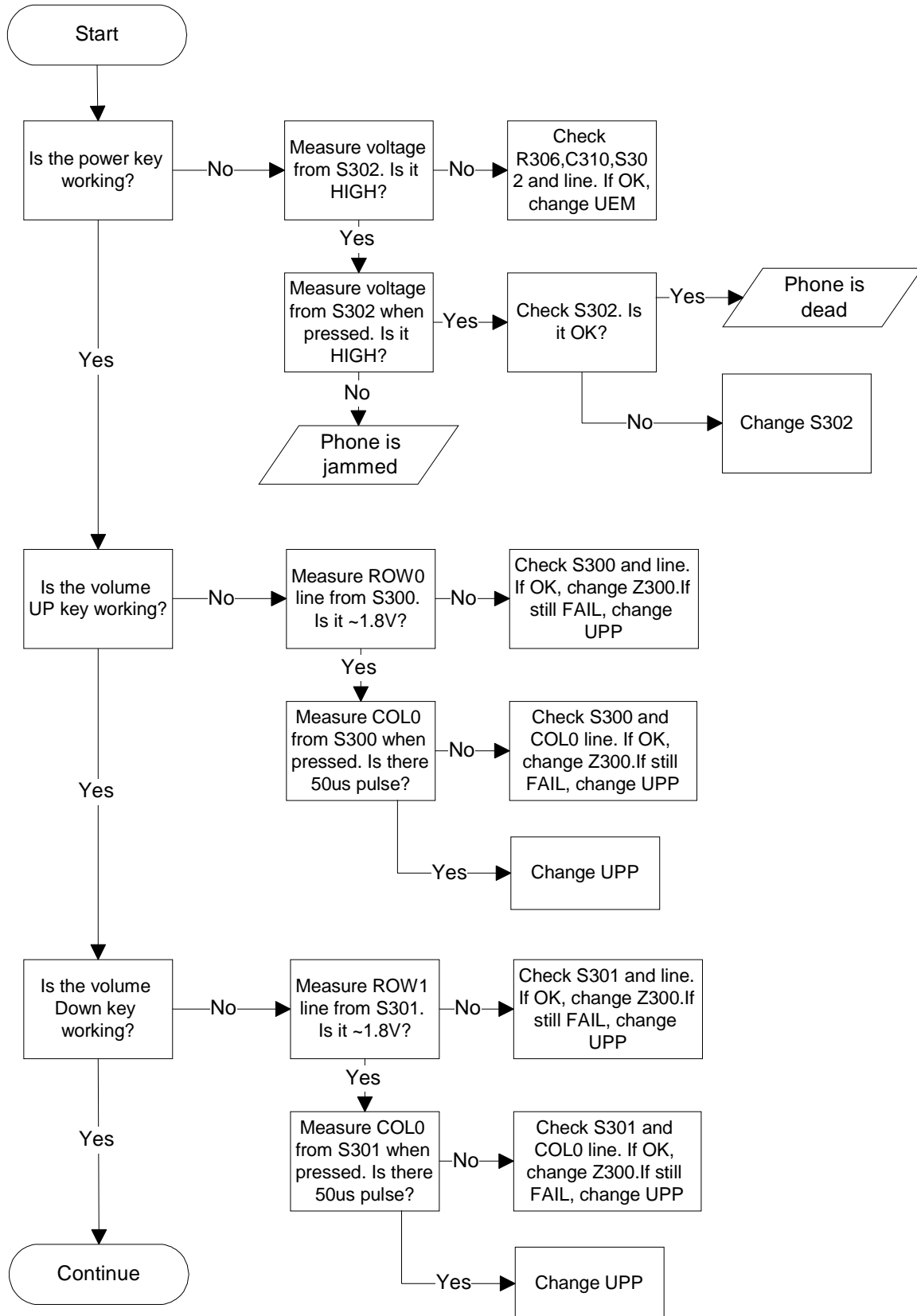
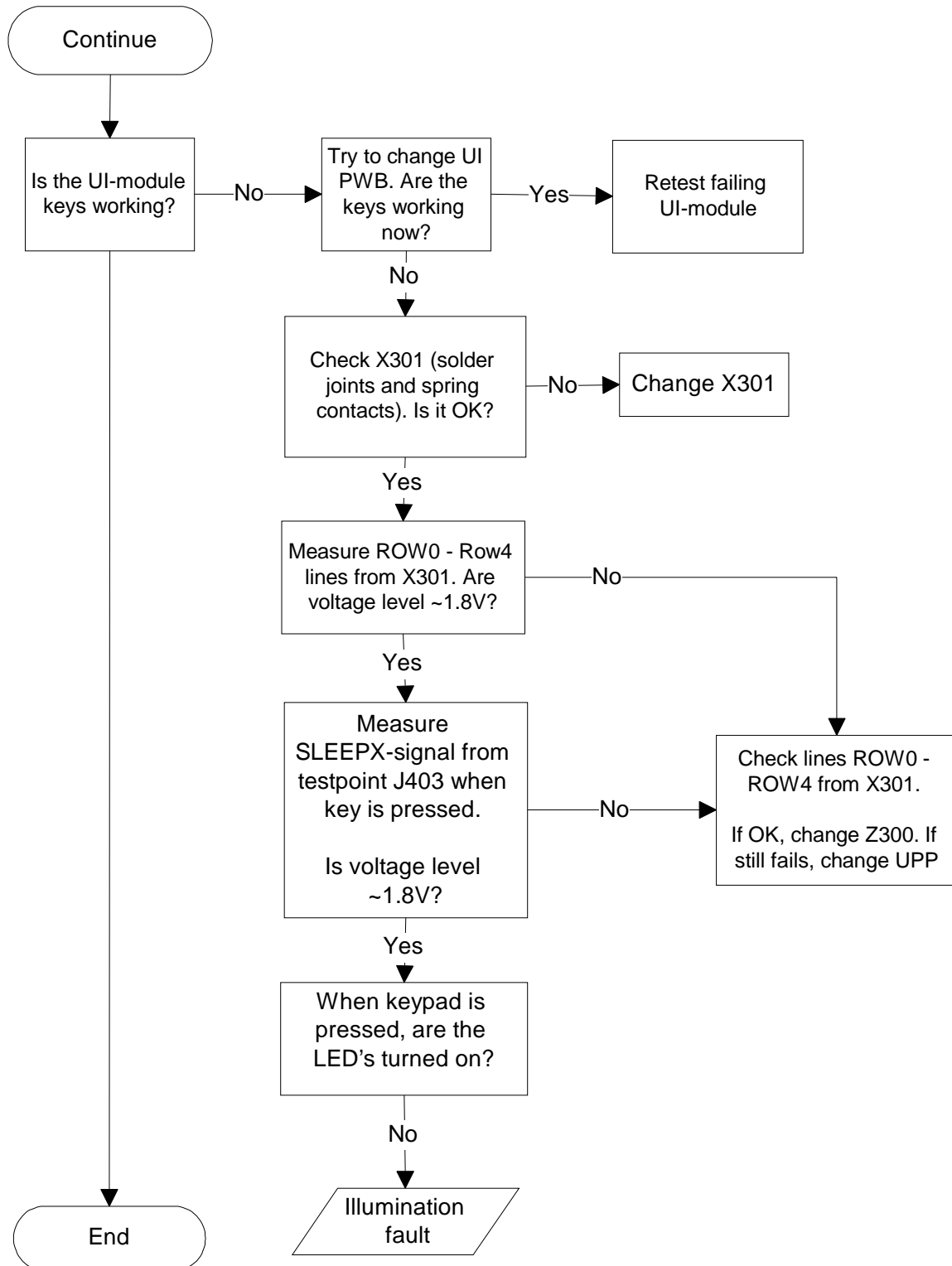
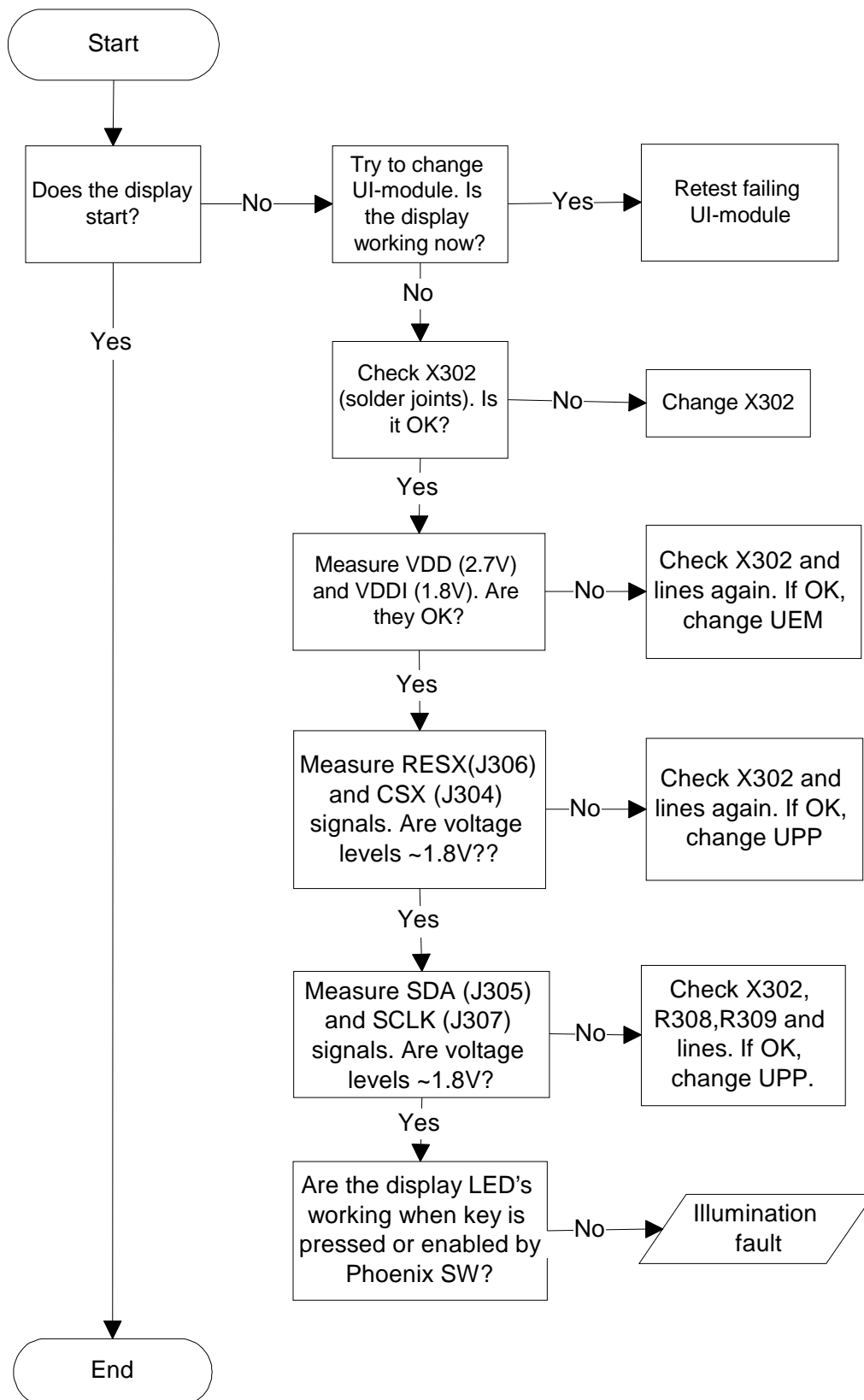

Figure 26: Keypad troubleshooting 2



## Display Fault

Figure 27: Display troubleshooting





Illumination fault

Figure 28: Backlight troubleshooting

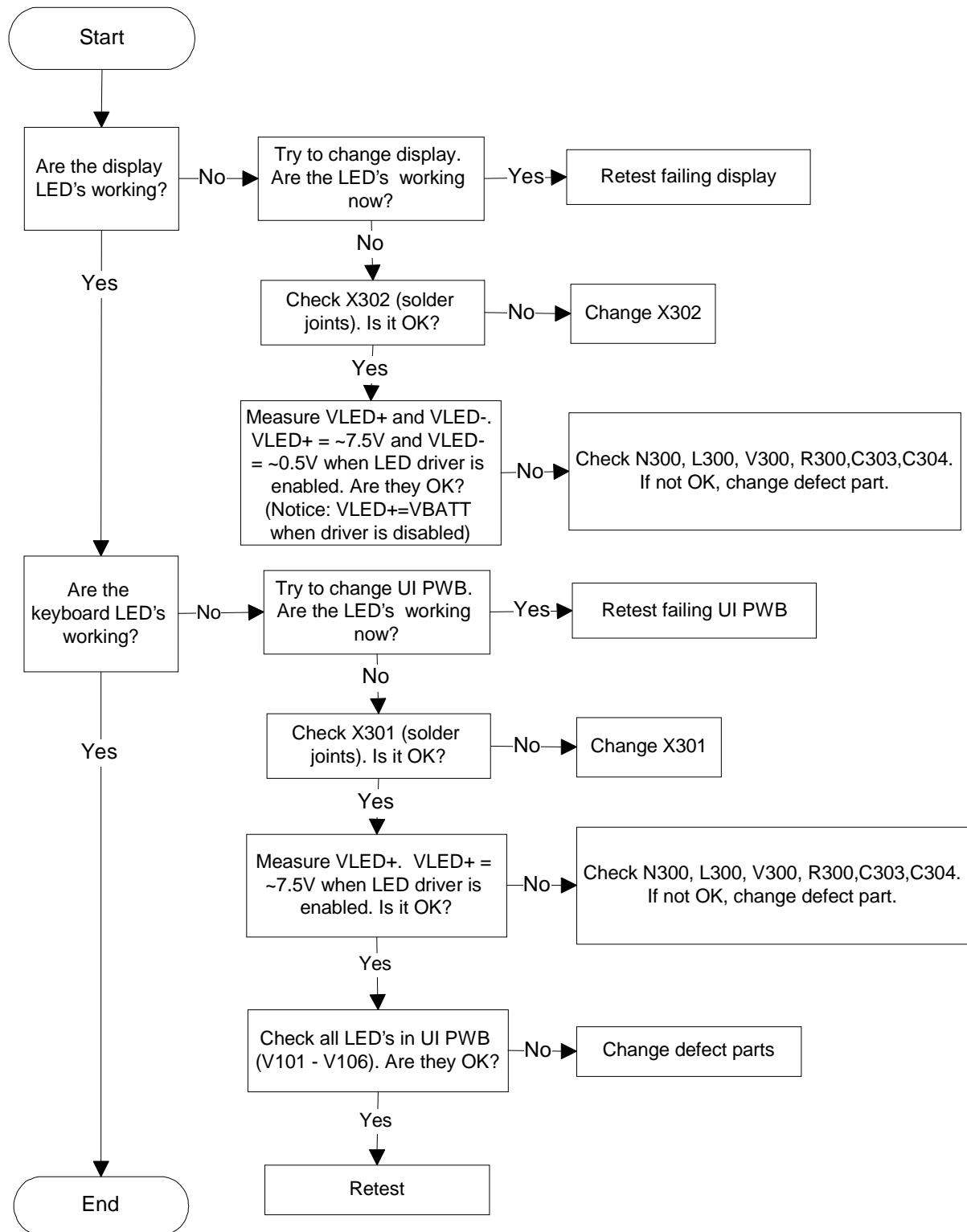

## Charger Fault

Figure 29: Charging troubleshooting

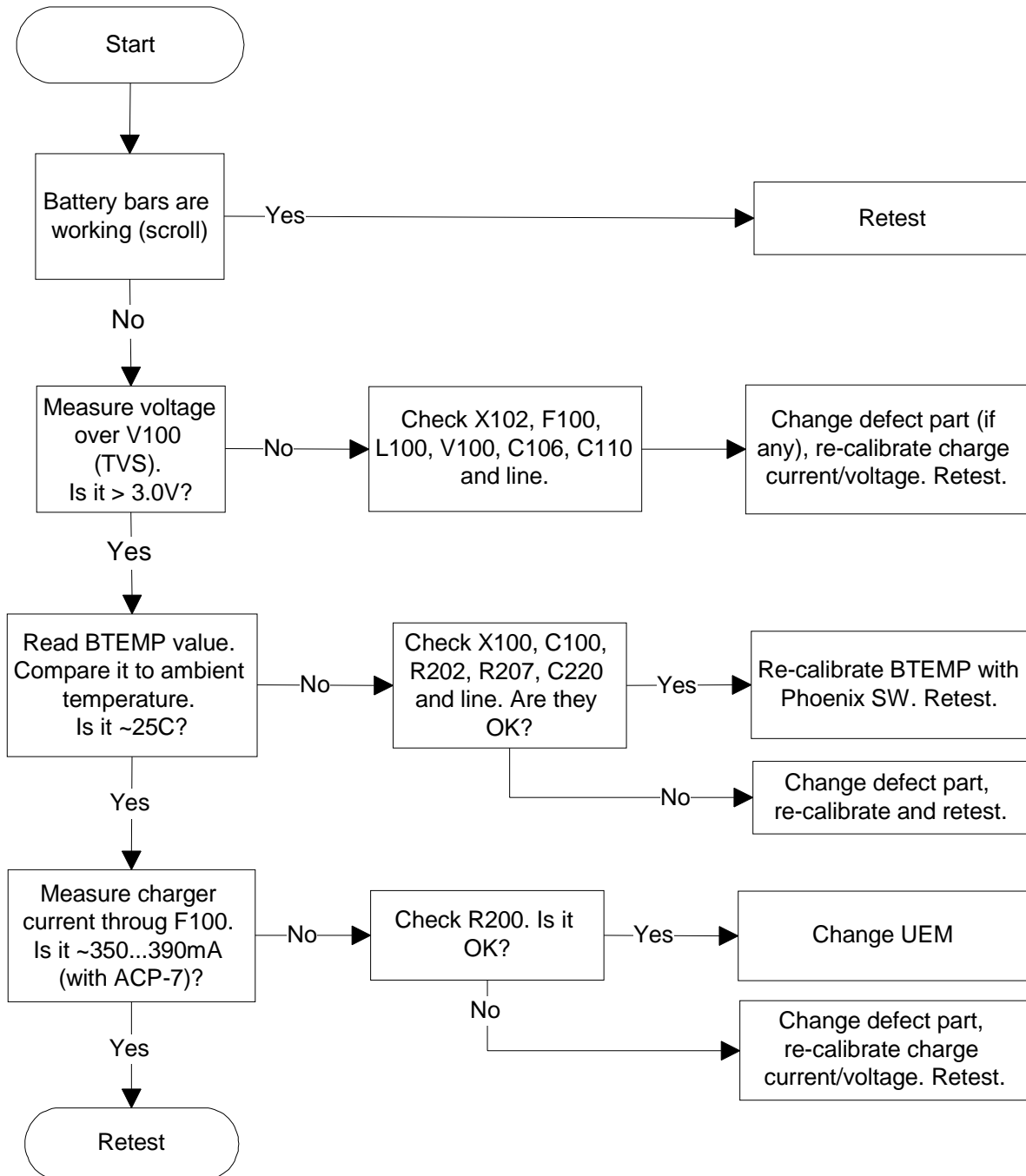

### Accessory Fault

Figure 30: Accessory troubleshooting

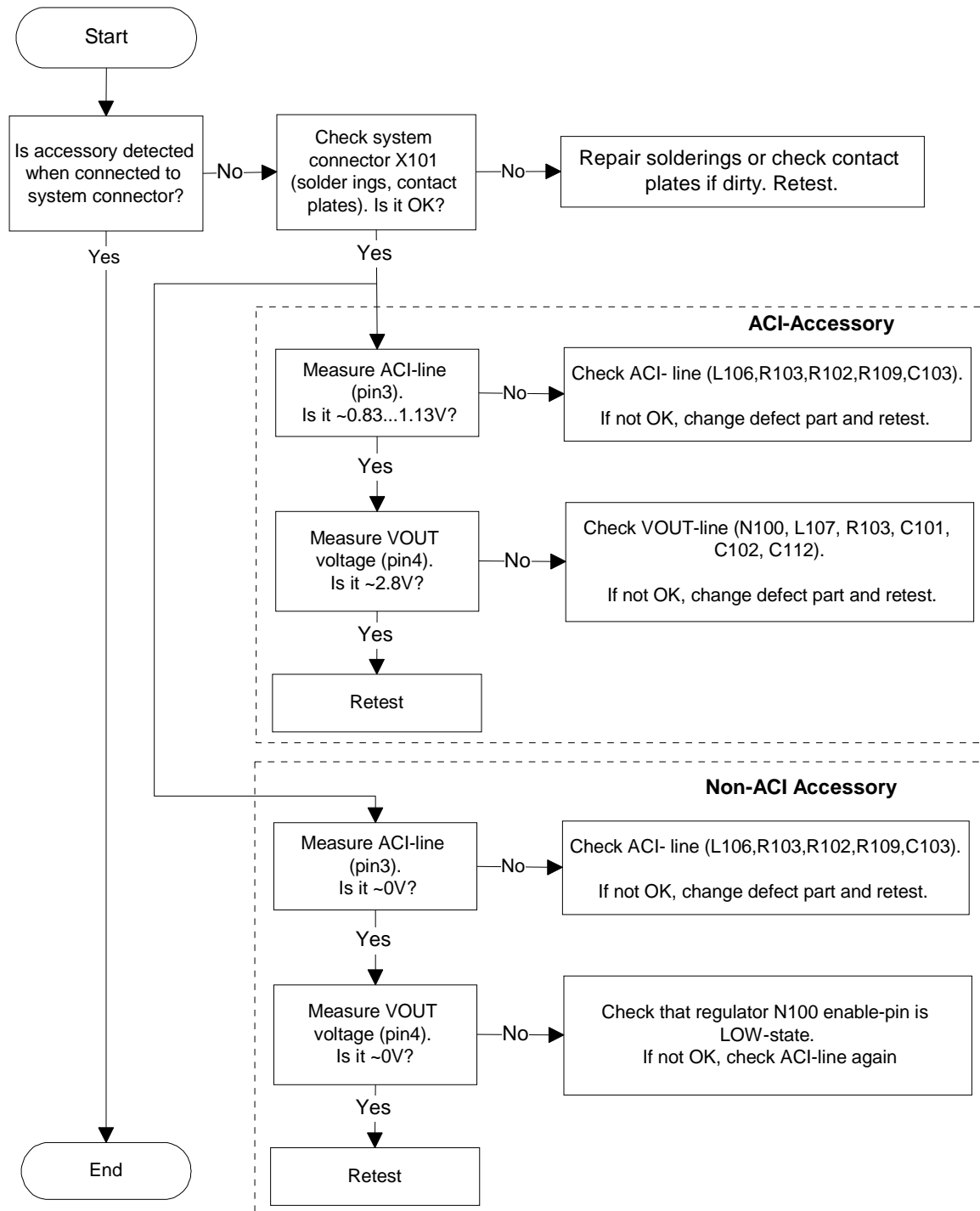

## Audio Fault

Figure 31: Audio troubleshooting

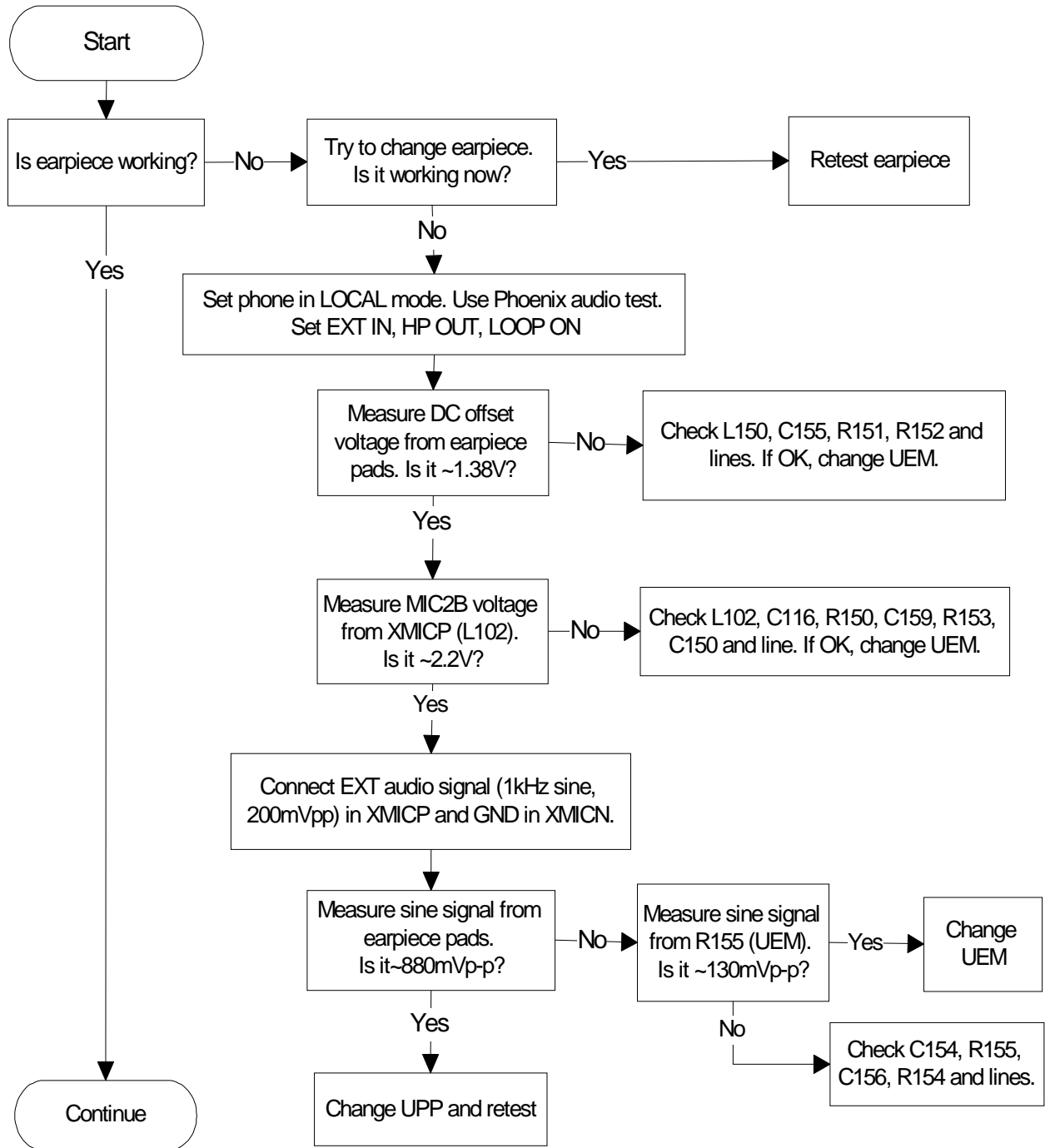

# FM Radio troubleshooting

## FM Radio component layout

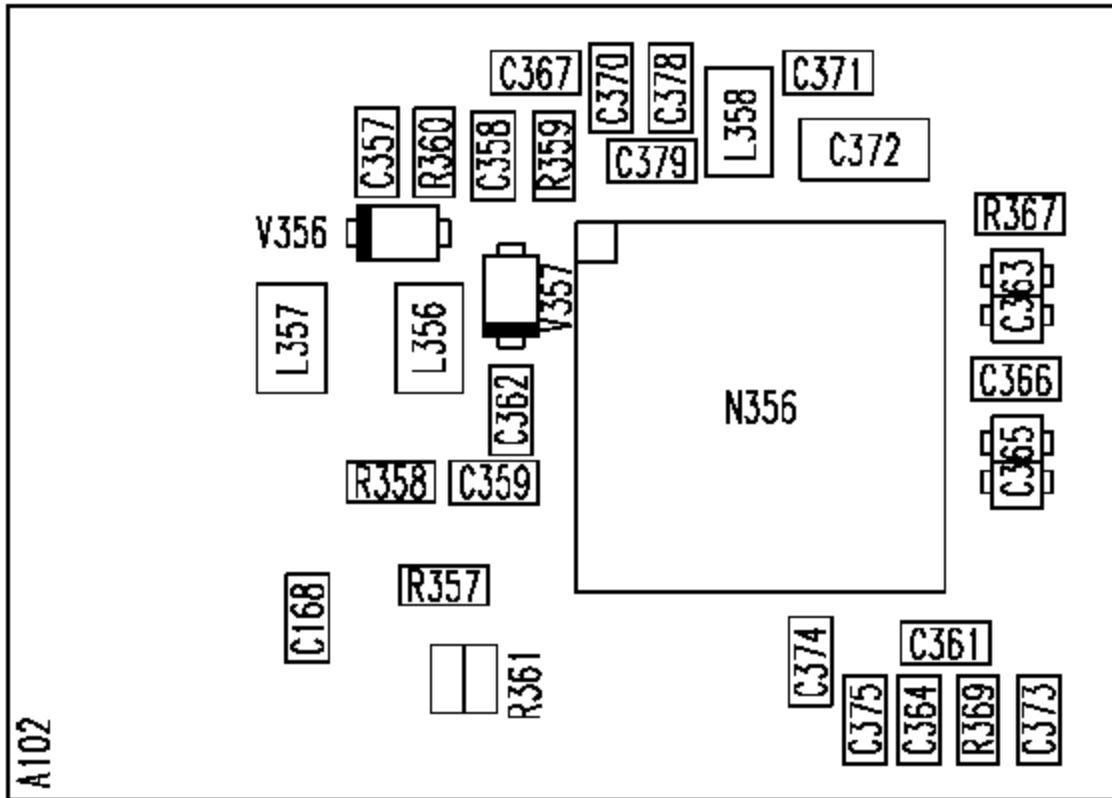

Figure 32: Component placement

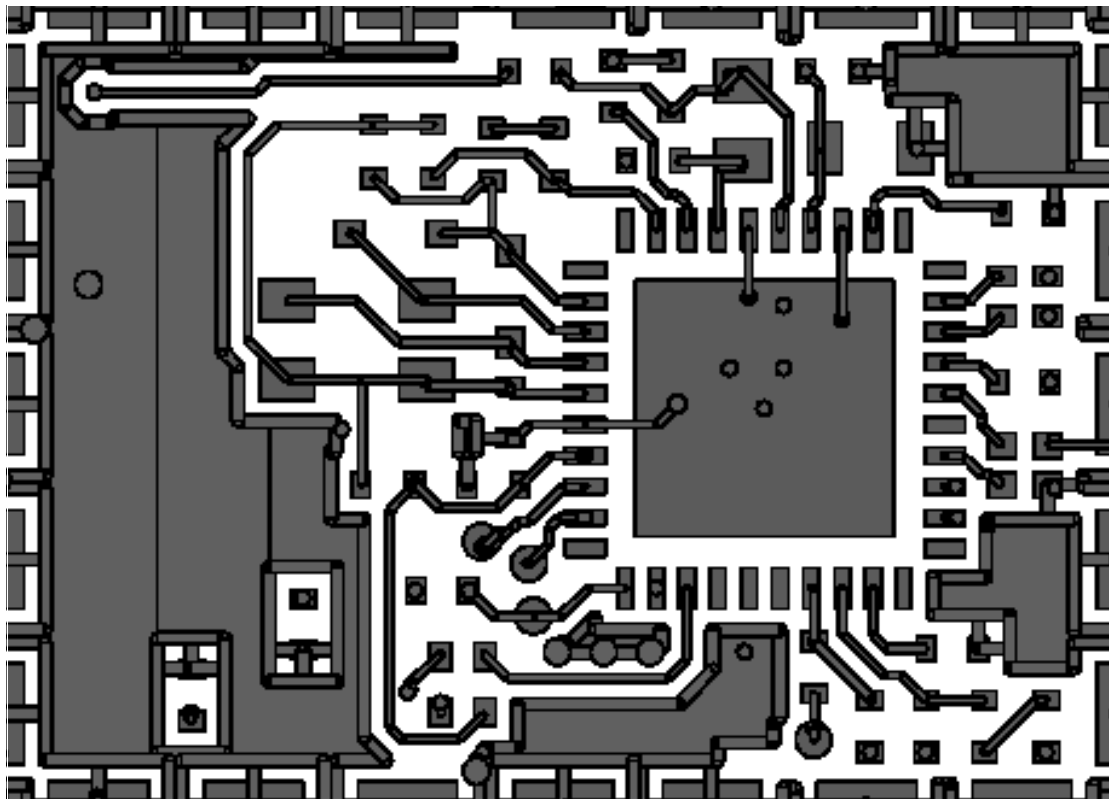

Figure 33: Trace layout.

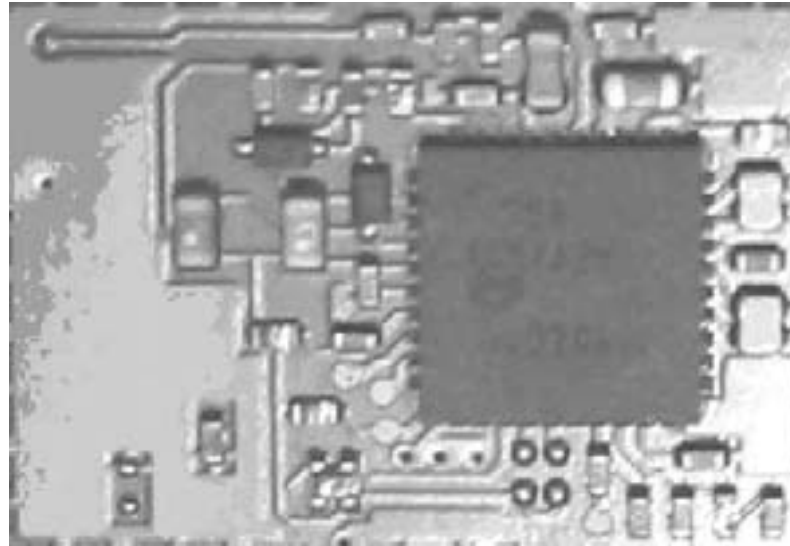

Figure 34: FM radio block layout.

Components L103, L104, L105, C107, C108, C109, C117, C162, C163, R164, R165, R166 and R167 are not shown in the picture. Those components are placed in baseband section, near audio amplifier N150.

## FM Radio troubleshooting diagram

### Notes to "FM Radio troubleshooting diagram"

Use 1MHz 1X probe when measuring Audio and clock signals with oscilloscope.

Use active RF probe when measuring frequencies with spectrum analyzer.

Note 1. RF test signal parameters:

- Amplitude,  $A$ , -67.0 dBm
- Carrier frequency,  $f_c$ , 98,000 MHz
- Deviation,  $\Delta f$ , 75 kHz
- Modulating frequency  $f_m$ , 1,000 kHz (RF generator internal)
- FM stereo, mode R=L, pilot state ON

Figure 35: FM radio troubleshooting diagram

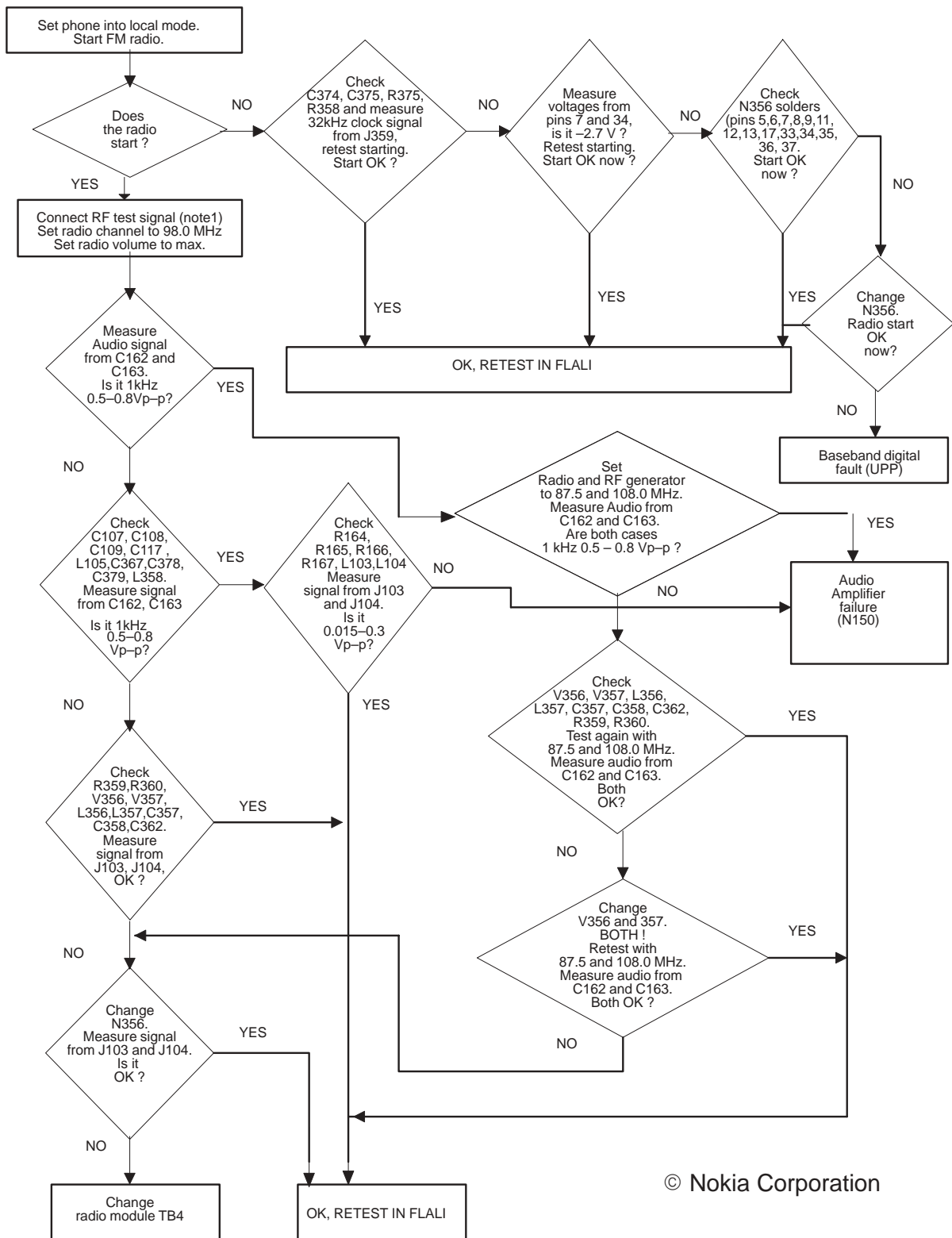

© Nokia Corporation

Diagrams of FM radio signals

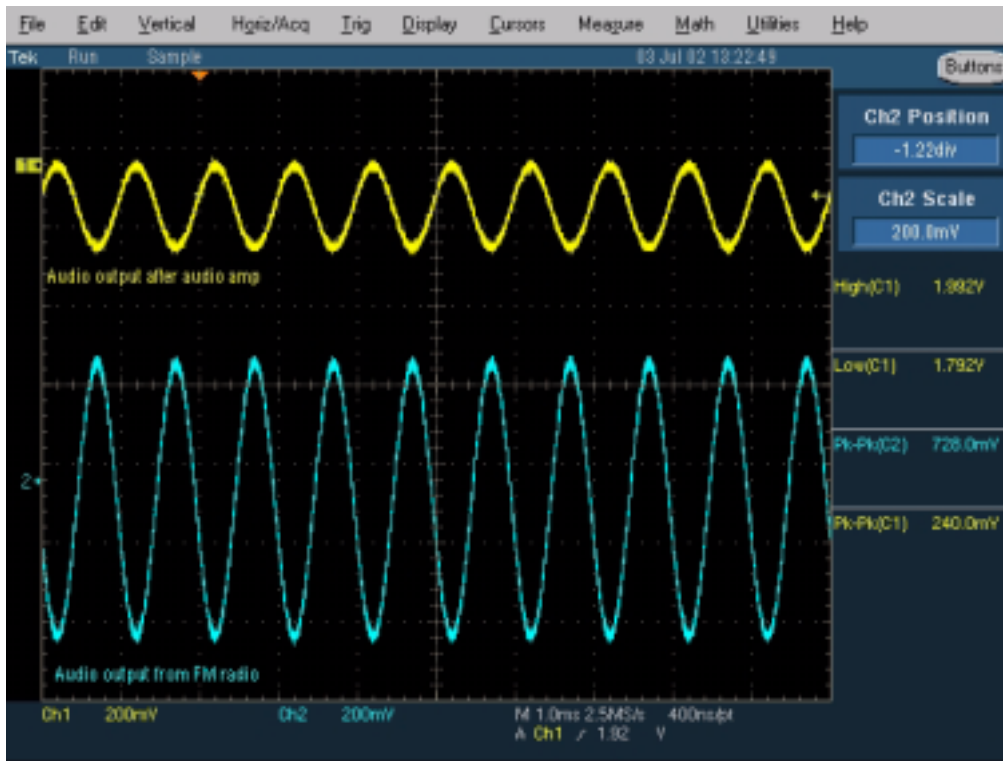

Figure 36: Oscilloscope screen shot, Audio output  
Signal 1: Audio output from PWB test points J103 and J104, with FM test signal, volume 100%.  
Signal 2: Audio output from FM radio pins 22 and 23(same as in C162 and C163), with FM test signal

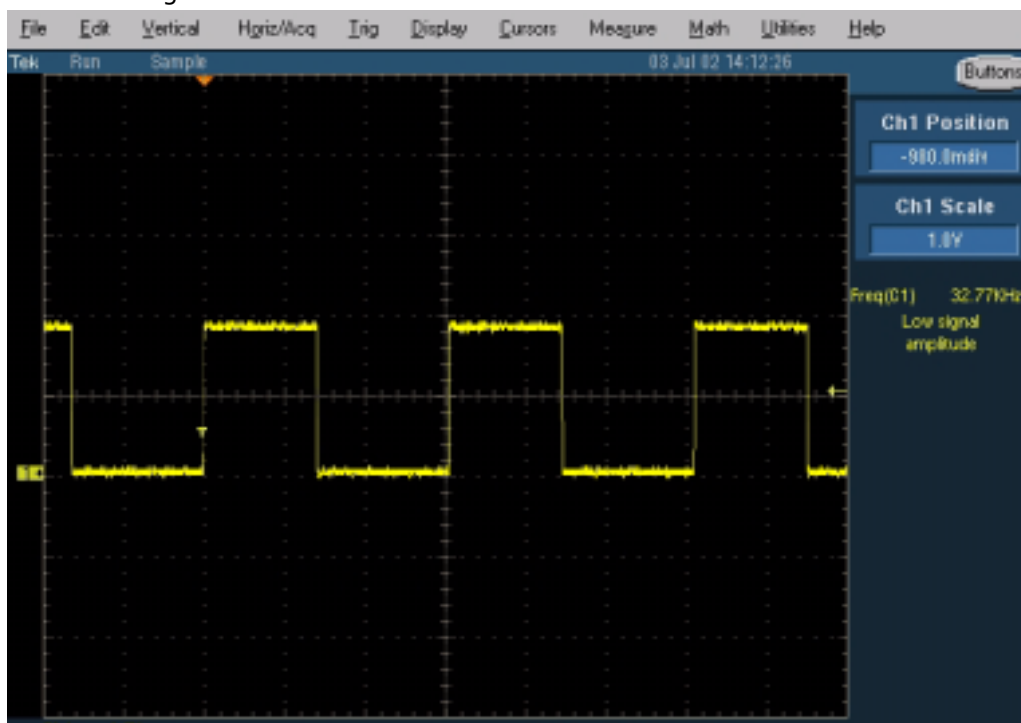



Figure 37: FM radio clock from test point J359, 32 kHz frequency clock signal, when radio is on.

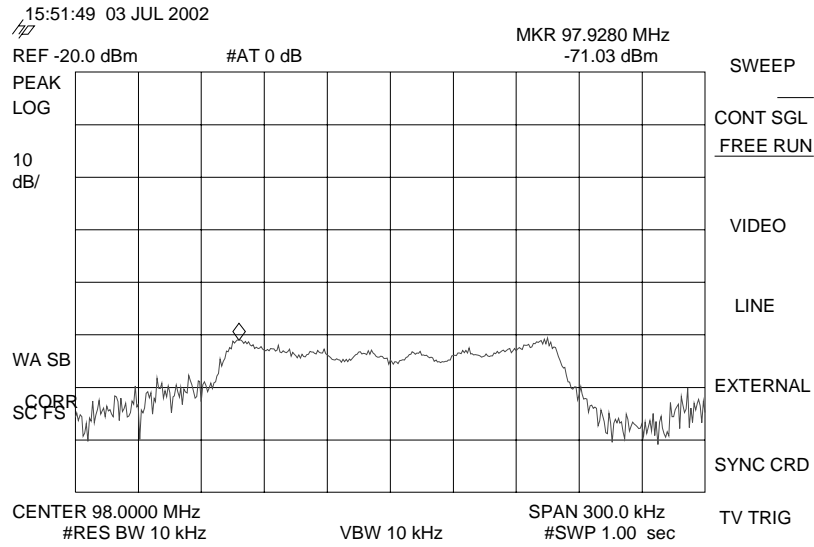

Figure 38: FM frequency from FM radio pin 37, the other end of L358, with FM test signal

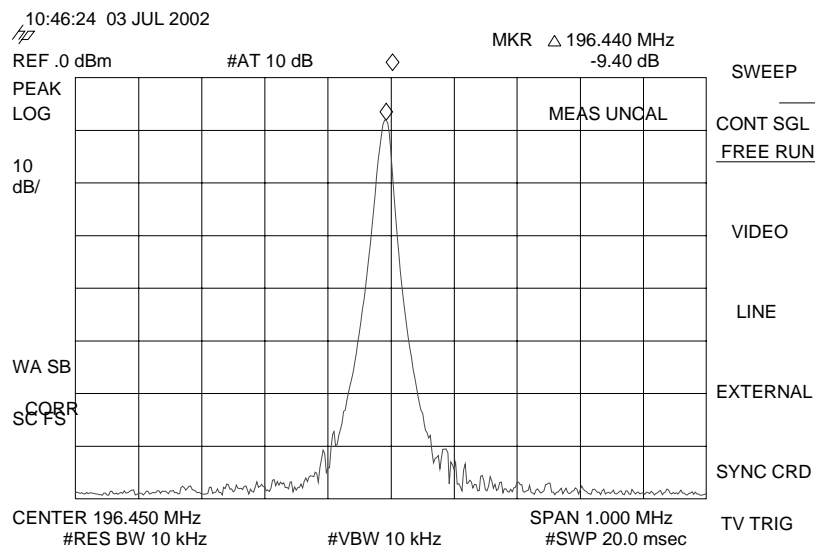

Figure 39: VCO frequency from FM radio pins 3 and 4, the other ends of V356 and V357, with FM test signal

